

LanTEK[®] II Series Manual



LanTEK®II Cable Certifier Instruction Manual

This instruction manual contains information proprietary to IDEAL INDUSTRIES, INC. The information in this document is not to be used or duplicated in any manner without prior written approval from IDEAL INDUSTRIES, INC.

IDEAL INDUSTRIES, INC. and the IDEAL INDUSTRIES, INC. logo are registered trademarks of IDEAL INDUSTRIES, INC.

All other product names mentioned in this manual are trademarked or copyrighted by their respective manufacturers.

IDEAL INDUSTRIES, INC.
9650 Chesapeake Drive
San Diego, CA 92123
Phone: (800) 854-2708
Phone: (858) 627-0100

Fax: (858) 715-7003

Manual Part No.: P-2877 Rev. B

© 2009 IDEAL INDUSTRIES, INC.

2009-12

Standard Warranty Policy of IDEAL INDUSTRIES, INC.

The General Terms and Conditions of the local subsidiary of IDEAL INDUSTRIES, INC. apply.

Safety Precautions

Exercise caution when handling rechargeable batteries (accumulators)

All lithium-ion battery packs (Li-ion), regardless of their indicated charge state, are capable of producing electrical current sufficient to cause personal injury and/or property damage.

Do not dispose of lithium-ion battery packs (Li-ion) in a fire or with regular waste. Lithium-ion battery packs (Li-ion) may explode if exposed to open flame. The battery packs are hazardous waste and may contaminate ground water sources if disposed of in landfills.

IDEAL INDUSTRIES, INC. tries to provide the maximum protection possible by installing an automatic reset fuse in the battery packs, to help stop high current discharge as quickly as possible. However, these fuses may not completely protect against a momentary arc discharge, which can result if the battery pack's electrical contacts are shorted. The following battery pack handling precautions must be closely followed to avoid risk of injury.

- When a battery pack is not installed in the Display (DH) or Remote (RH) handset, it should be kept in a clean, dry, non-conductive package.
- Keep conductive materials away from the battery pack at all times.
- Keep contact sides of the battery pack away from each other at all times.
- Battery packs can be charged while in the Display (DH) and in the Remote (RH) handset, but also externally with the adapter. Charging in any other manner may cause the battery pack to explode.
- Always install, remove, store, and charge the battery packs in a non-explosive atmosphere.
- Observe operating and storage temperatures (see chapter 1.3. Dimensions, Weights, Operating Conditions).
- Do not allow children or persons unfamiliar with the precautionary instructions in this manual to handle or recharge the battery packs.
- Do not open the battery pack case. There are no user-serviceable parts inside the case, and the batteries in the case are not replaceable.

Disclaimer

IDEAL INDUSTRIES, INC. does not assume any liability for death, injury or damage to equipment or property resulting from improper use of the battery packs.

IDEAL INDUSTRIES, INC. will not be liable for consequential damages that may result from tampering with the battery packs or charger or their use thereafter.

Subject to technical changes.

Environmental Protection

If you have any questions concerning these precautions, the operating instructions, or any other concerns about the safe use and disposal of the battery packs used in LanTEK®II, please contact a representative of IDEAL INDUSTRIES, INC. For contact information, please refer to Chapter *Customer Service*.

Using the LanTEK®II Cable Certifier

All cable parameter default settings programmed in the LanTEK®II Cable Certifier are based on generic standards, proposed industry recommendations for cables and network links, the latest technical information available from International LAN cabling standards committees, the LAN industry, and IDEAL INDUSTRIES' own experience and testing.

Before performing any measurements, IDEAL INDUSTRIES, INC. recommends to request detailed information from contractor or project manager on the standards to be used for measuring, to ensure that relevant parameters are complied with.

Information on the use of this Instruction Manual

The following symbols used in this manual indicate that the user should exercise particular caution in order to prevent personal injury or damage to the LanTEK®II Cable Certifier or the system under test.



WARNING!

This symbol indicates potentially lethal voltages. The life and/or health of the person performing the activity or anybody in the vicinity is at risk.



CAUTION!

This symbol indicates that the relative activity could possibly harm the environment or damage technical equipment.

NOTE:

Here you will find general notes, additional information, or support.

Typographical Conventions

Boldface

Refers to a button on LanTEK®II Cable Certifier.

Italics

Refers to a menu option in this Operating Manual.

Quotation marks " "

Identifies a "Screen Message".

CHAPTER 1	Your LanTEK® II Cable Certifier	9
1.1.	Technical Information	9
1.2.	Product Specifications	10
1.3.	Dimensions, Weights, Operating Conditions	10
1.4.	Performance Specifications	11
CHAPTER 2	Product Description	12
2.1.	The Display Handset (DH)	12
2.1.1.	Controls and Ports/Connectors	12
2.1.2.	TFT Display	14
2.1.3.	Function Keys F1 to F10	15
2.1.4.	Soft Key	15
2.2.	The Remote Handset (RH)	16
2.2.1.	Controls and Ports/Connectors	16
2.3.	Power Management	18
2.3.1.	Operating the Display and Remote handset from AC Power	18
2.3.2.	Battery Charging	19
2.4.	Talkset	19
CHAPTER 3	Basics of the Cable Test	20
3.1.	Testing of cables and relevant requirements	20
3.1.2.	Setup for Permanent Link Test	20
3.1.3.	Setup for Channel Link Test	20
CHAPTER 4	Preferences	21
4.1.	Open Preferences	21
4.2.	Language	21
4.3.	User Information	22
4.4.	Autotest Options	22
4.5.	Contrast	23
4.6.	Timeout Options	23
4.7.	Measurement Units	24
4.8.	Talkset	25
4.9.	Date and Time	25
4.10.	Restore Default	26
4.11.	Clear Memory	27
4.12.	Temperature	27
CHAPTER 5	Autotest	28
5.1.	Set Autotest Pref	29
5.2.	Select Job Folder	30
5.2.1.	Enable Existing Job Folder	30
5.2.2.	Create New Job Folder	31
5.3.	Set Cable Name (cable ID)	33
5.3.1.	Simple Cable ID	34

5.3.2.	Default Cable ID	35
5.4.	Labeling Standard TIA/EIA 606-A.....	37
5.4.1.	Cable Name in Format TIA/EIA 606A	38
5.4.2.	Cable Parameter 606A Drop	38
5.4.3.	Cable Parameter 606A Backbone.....	39
5.4.4.	Cable Parameter 606A Backbone Pair/Fiber	39
5.5.	Select Twisted Pair Cabling.....	40
5.5.1.	Specify Cable Type	41
5.5.2.	Create Cable Type.....	41
5.5.3.	Edit and Calculate NVP.....	44
5.5.4.	Enter Reference Temperature	45
5.6.	DualMODE™ Function for Twisted Pair Cabling	46
5.6.1.	Implement DualMODE™	46
5.7.	Edit NVP Default Value of a Cable.....	47
5.8.	Coaxial Cable Standards	48
5.8.1.	Autotest Test Series for Coaxial Cables	49
5.9.	Calibration	50
5.9.1.	Twisted Pair Cabling	50
5.9.2.	Coaxial Cable.....	52
5.10.	Perform Autotest.....	53
5.11.	Open Job Folder of Autotest.....	53
5.11.1.	Job Options	53
5.11.2.	Test Options	53
5.11.3.	Copy Job Folder to USB Removable Storage	54
5.11.4.	Alien Crosstalk Measurements (AXT).....	54
5.12.	Autotest Results and Graphs.....	54
5.12.1.	Graph Formats, Layouts and Controls	56
CHAPTER 6	Structured Cabling Testing	58
6.1.	Test Setup for Single Test Analysis.....	58
6.2.	Test Run of Single Test Analysis.....	58
6.3.	Perform Single Test Analysis	58
6.4.	Evaluation of Analysis Test Results.....	59
6.4.1.	Graphs for Analysis Tests	59
6.5.	Overview of Single Test Analysis.....	59
6.6.	Wiremap Test	60
6.7.	Length Test.....	61
6.7.1.	Length Test Error	61
6.8.	Resistance Test.....	61
6.8.1.	Resistance Test Error.....	61
6.9.	NEXT, ACR-F (ELFEXT) and Power Sum.....	61
6.10.	Power Sum NEXT, Power Sum ACR-F (ELFEXT)	62
6.10.1.	NEXT Test and ACR-F (Power Sum ELFEXT) Test Error	63
6.11.	Insertion Loss Test (Attenuation)	64

6.11.1. Insertion Loss test Error	64
6.12. Return Loss Test	64
6.12.1. Return Loss Test Error	64
6.13. Impedance Test	65
6.13.1. Impedance Error	65
6.14. Delay and Skew Test	65
6.14.1. Delay and Skew Test Error	66
6.15. Capacitance Test.....	66
6.15.1. Capacitance Test Error	66
6.16. ACR-N (ACR) Test and Power Sum ACR-N (Power Sum ACR) Test	66
6.16.1. ACR-N (ACR) Test and Power Sum ACR-N (Power Sum ACR) Test Error	67
6.16.2. Troubleshooting ACR-N (ACR) Test and Power Sum ACR-N (Power Sum ACR)	67
6.17. Headroom Test	67
6.17.1. Headroom Test Error	67
6.18. Custom Cable Preferences and Cable Parameters	68
6.18.1. Creating a New Customs Cable Type.....	68
6.18.2. Select Custom Cable Type	69
6.18.3. Custom Cable Parameters	69
CHAPTER 7 Coaxial Cable Test.....	71
7.1. Properties of Coaxial Cables	71
7.2. Troubleshooting Coaxial Cables.....	71
CHAPTER 8 Fiber Testing with FiberTEK™ FDX	72
8.1. Safety Precautions	72
8.2. Notes on Cleaning Measuring Adapter and Patch Cord	72
8.3. Performance Specification	73
8.4. Test Setup According to Reference Method with Three Test Cords	74
8.5. Test setup According to Reference Method with One Test Cord	74
8.6. Set Autotest Pref	75
8.6.1. Selection of Module (fiber type)	75
8.6.2. Determine Loss Budget.....	75
8.7. Calibration	77
8.8. Performing Calibration	77
8.9. Evaluation of Autotest Results for Fibers (LWL)	78
8.9.1. Passed/Failed Rating	78
8.9.2. Saving Current Autotest Results.....	78
8.9.3. Manual Saving of Autotest Results (Autosave off).....	79
8.9.4. Working with Jobs	79
8.9.5. Display of Result Details	79
8.10. FiberTEK™ FDX Measuring Mode	79
8.10.1. Continuous Run.....	80
8.10.2. Power Meter Mode.....	81
8.10.3. Set Reference Value	81

8.10.4. Light Source Mode.....	81
8.11. Application-specific Configuration of a Fiber Test.....	82
8.11.1. Determine Loss Budget.....	82
8.11.2. Select Fiber Standard and Determine Loss Budget.....	83
CHAPTER 9 Tone Generator.....	86
9.1. Tone Generator.....	86
9.1.1. Enable Tone Generator with Display handset (DH).....	86
9.1.2. Enable Tone Generator with Remote handset (RH).....	87
CHAPTER 10 IDEAL DataCENTER Software.....	88
10.1. Installing Software.....	88
10.1.1. System Requirements.....	88
10.1.2. Start Installation.....	88
10.2. Select Language.....	89
10.3. Software-Update.....	89
10.3.1. Retrieve Version.....	89
10.3.2. Perform Update.....	89
10.4. Databases.....	90
10.4.1. Create a new database.....	90
10.4.2. Open an existing database.....	91
10.5. Transfer job file.....	92
10.5.1. Upload from LanTEK®II Cable Certifier.....	92
10.5.2. Import from the computer or an external data carriers (USB Flash Drive).....	94
10.5.3. Export job folder.....	95
10.5.4. Rename job folder.....	96
10.6. Manage Tests.....	97
10.6.1. Edit information.....	97
10.6.2. Edit tests and test records.....	98
10.6.3. Test details.....	98
10.6.4. Graphs.....	99
10.7. Produce and print reports.....	100
10.7.1. Set up header and footer.....	100
10.7.2. Define test selection.....	101
10.7.3. Print.....	101
10.8. Online Help.....	102
CHAPTER 11 LANTEK Firmware Upgrade.....	103
11.1. Perform Firmware Upgrade.....	103
11.1.1. Using the Computer.....	103
11.1.2. Firmware Upgrade with USB Removable Storage.....	104
CHAPTER 12 Specifications.....	105
12.1. Fiber (LWL).....	105
CHAPTER 13 Customer Service.....	107

13.1.	Technical Support	107
13.2.	Service in the US	107
13.3.	Service outside the US.....	107
13.4.	Internet	109

CHAPTER 1

Your LanTEK®II Cable Certifier

The LanTEK®II Cable Certifier is designed to measure twisted pair cables (TP), coaxial cables and fiber-optic cables (LWL) used for high-speed data transmission in communications networks.

1.1. Technical Information

Features	LanTEK®II-350	LanTEK®II-500	LanTEK®II-1000
Frequency range	350 MHz	500 MHz	1000 MHz
Cable specification CAT 3/ISO C, CAT 5/ISO D, 5e/D new, 6/E	✓	✓	✓
Cable specification CAT 6 _A /ISO E _A	Upgradeable	✓	✓
Cable specification ISO F, ISO F _A	Upgradeable	Upgradeable	✓
Accuracy level (LanTEK®II)	IV (ETL)	IV (ETL)	IV (ETL)
DualMODE™-tests	✓	✓	✓
Test with patch cord	✓	✓	✓
CAT 6 test storage capacity with graphs	1700	1700	1700
USB port	✓	✓	✓
Serial port (concerns only Service)	✓	✓	✓
Fiber (LWL) loss and length measurement (FiberTEK™ FDX)	Optional	Optional	Optional
Communication over fiber (LWL) and copper (Full Duplex)	✓	✓	✓
LCD-display on Remote handset (RH)	✓	✓	✓
Tone generator to determine connection on near and remote end	✓	✓	✓
Lithium-ion battery packs	✓	✓	✓

1.2. Product Specifications

Standard Test Compliance

ANSI/TIA/EIA 568A, 568B, CAT 6A/6/5E/3, ISO F_A/F/E_A/D/C, AS/NZS 3080, IEEE 802.3 Ethernet, EN50173 – F/E/D/C

Cable Types

UTP/SCTP/FTP CAT 3/5E/6A/7 (100 Ω); Coax (50/75 Ω)

1.3. Dimensions, Weights, Operating Conditions

Dimensions:

(L) 254 mm x (W) 127 mm x (D) 53 mm

Weights:

Display handset (DH)	1180 g (incl. battery)
Remote handset (RH)	1120 g (incl. battery pack)
Battery pack	548 g

Battery Packs Display Handset (DH) and Remote Handset (RH):

Lithium-ion battery packs (Li-ion)

Operating life with Battery Pack:

18 hours under normal conditions

Charging Time:

In handset 6-8 hours

External 4 hours

Operating Temperature (min/max):

0° C to +50° C (Operate only if handset temperature is close to ambient temperature!)

Storage Temperature (min/max):

-20° C to +70° C

Relative Humidity:

5% to 90%, noncondensing

1.4. Performance Specifications

LanTEK®II	Range	Resolution	Accuracy
Length (50 - 100 Ω cable)	0 - 605 m	0.1 m	± (3 % + 1 m)
Delay	0 - 8000 ns	1 ns/0.1 m	± (3 % + 1 ns)
Average impedance	35 - 180	0,1	± (3 % + 1)
Capacitance (bulk)	0 - 100 nF	1 pF or 3 digits	± (2 % + 20 pF)
Capacitance	0 - 333 pF/m	0.1 pF	± (2 % + 1 pF)
DC loop resistance	35 -200	0,1	± (1 % + 2)
Attenuation	1 MHz - 1 GHz	0.1 dB	Level IV
NEXT (crosstalk)	1 MHz - 1 GHz	0.1 dB	Level IV
Return loss	1 MHz - 1 GHz	0.1 dB	Level IV
ELFEXT / ACR-F	1 MHz - 1 GHz	0.1 dB	Level IV
ACR / ACR-N	1 MHz - 1 GHz	0.1 dB	Level IV

CHAPTER 2 Product Description

2.1. The Display Handset (DH)

The Display handset (DH) ensures control of preferences and test functions during individual cable tests.

2.1.1. Controls and Ports/Connectors

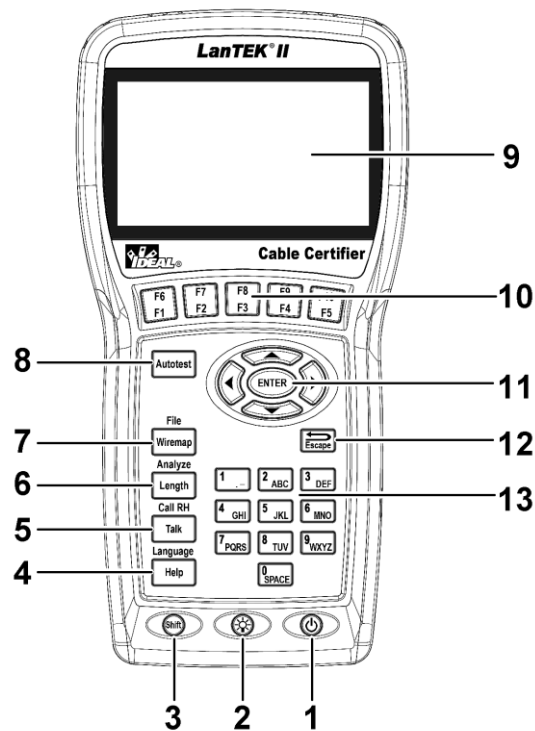

**Illustration 1 2.1. The Display Handset (DH)
Front view**

	Controls	Description
1	On/Off	Power the Display handset (DH) on/off.
2	Dim Backlight	Dim Backlight in two stages.
3	Shift	Toggle key activities having dual functions.
4	Help / Language	Open Help Menu / Open Language Selection
5	Talk / Call RH	Activate Talkset function / call Remote Handset (RH).
6	Length / Analyze	Open Length Measurement / Open Diagnostics Menu.
7	Wiremap / File	Open analyze function "Wiremap" / Open Job List.

	Controls	Description
8	Autotest	Direct execution of test run pre-programmed for established standards.
9	TFT-Display	Display of menus, test results, graphs, activity selection and function keys.
10	Function keys F1 to F5 / F6 to F10	Select menu options displayed on screen.
11	Arrow Keys / Enter	Navigate menus on TFT Display / Enter key to activate and edit the selected menu.
12	Escape	Abort and exit the current menu without making changes.
13	Alphanumeric Keys	Enter numbers, letters and special characters.

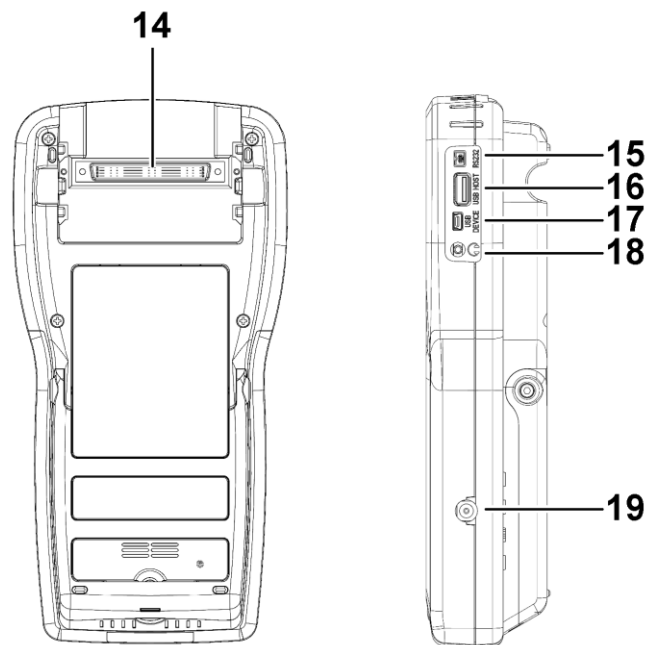

Illustration 2 2.1.1. The Display Handset (DH)
Rear and side view

	Ports/Connectors	Description
14	Low-NEXT-Connector	Connect a test adapter.
15	Service and Maintenance Jack	Connection for service and maintenance work.
16	USB Port	Connect USB removable storage to transmit data and to load Firmware-Updates.
17	USB Device	Connect to a computer
18	Talkset Jack	Connect a Talkset.
19	DC Input Jack	Connect an external power supply and charge battery pack.

2.1.2. TFT Display

Ready screen appears on operational Display handset (DH).

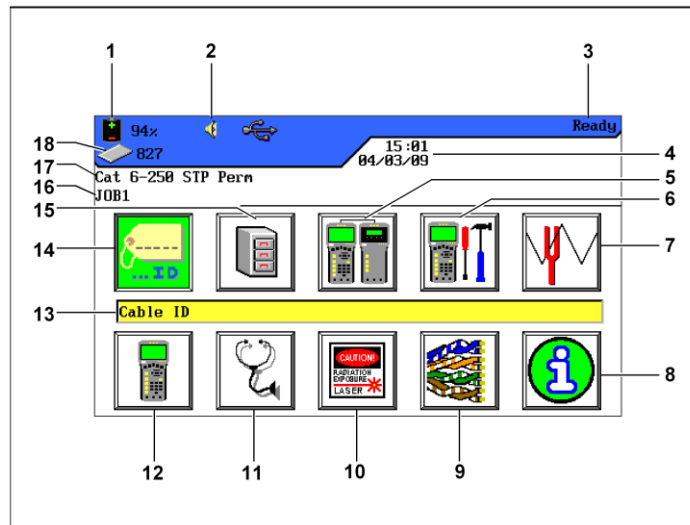

Illustration 2.1.2. TFT Display

	Display	Description
1	Power supply and charge state	Indicates battery operation or external power supply and charge state of battery pack (%).
2	Talkset indicator	Indicates whether talkset function is active.
3	Screen Title	Indicates that display handset (DH) or selected function is ready.
4	Time and Date	Displays the time and date.
5	Field calibration	Select the field calibration.
6	Preferences	Select the instrument preferences.
7	Toner	Select the tone generator.
8	General Help	Select the Help menu.
9	Cable Type	Select or edit the cable type.
10	Fiber	Select the fiber measurement.
11	Analyze	Perform individual cable tests in real time.
12	Instrument	Display the information on LanTEK®II Cable Certifier.
13	Function Name	Displays the name of highlighted function.
14	Cable ID	Select cable naming function.
15	Stored Tests	Select file manager for the stored tests.
16	Job Name	Display the current job name.
17	Test Standard	Display the cable type selected for tests.
18	Records	Number of records stored.

2.1.3. Function Keys F1 to F10

Function keys **F1** to **F5** have dual functions (**F6** to **F10**). Pressing down the **Shift** key while simultaneously pressing one of the function keys **F1** to **F5** will activate the 2nd function of the function key (example: **Shift + F4** equals function **F8**).

2.1.4. Soft Key

Soft keys indicate possible menu options at the bottom of the screen. To select the according option, press the corresponding **Function Key (F1 - F5)** below the soft key.

The example below shows the setting of Timeout options by using the soft keys at the bottom of the screen. The Value is set by **Function Keys F1** (Increase) and **F2** (Decrease).

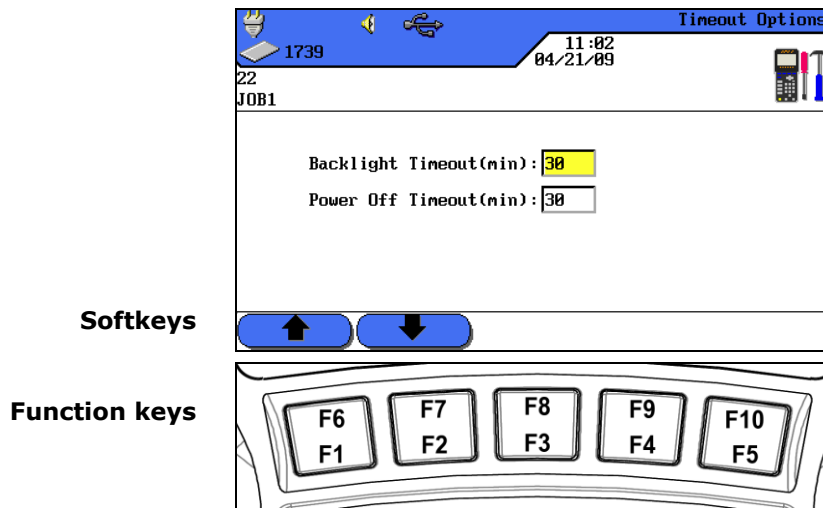
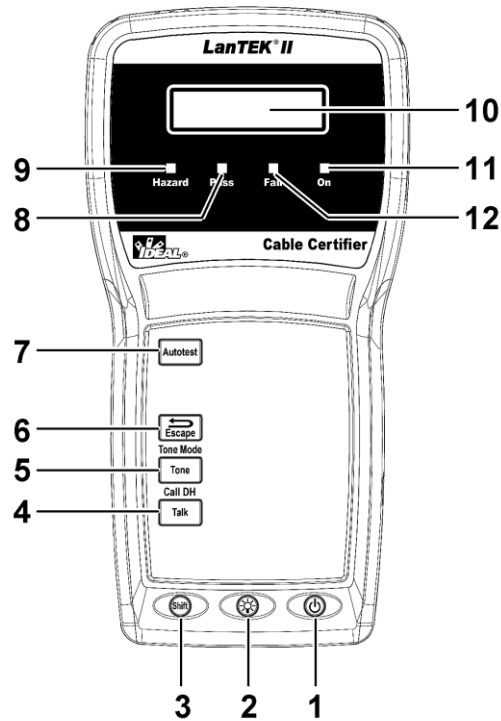

Illustration 2.1. Soft keys and function keys

2.2. The Remote Handset (RH)

The Remote handset (RH) works with the Display handset (DH) to perform autotests or individual real time analyze tests. The Remote handset (RH) is located at the end of the cable link and communicates with the Display handset (DH). To perform measurements, the Remote handset (RH) is automatically activated by the Display handset (DH).

2.2.1. Controls and Ports/Connectors



**Illustration 2.2.1. The Remote Handset (RH)
Front view**

	Controls	Description
1	On/Off	Power the Remote handset (RH) on/off.
2	Dim Backlight	Dim Backlight in two stages.
3	Shift	Toggle key activities having dual functions.
4	Talk / Call DH	Activate Talkset function / call Remote handset (RH).
5	Tone / Tone Mode	Power the tone generator on/off.
6	Escape	Abort and exit the current action without making changes.
7	Autotest	Start the Autotest.
8	Pass LED	Test result: Passed.

	Controls	Description
9	Hazard LED	Excessive line voltage (TELCO): Excessive voltage at measurement input.
10	S/W-LCD Display	Two line alphanumeric display
11	On LED	The Remote Handset is on.
12	Fail LED	Test result: Fail.

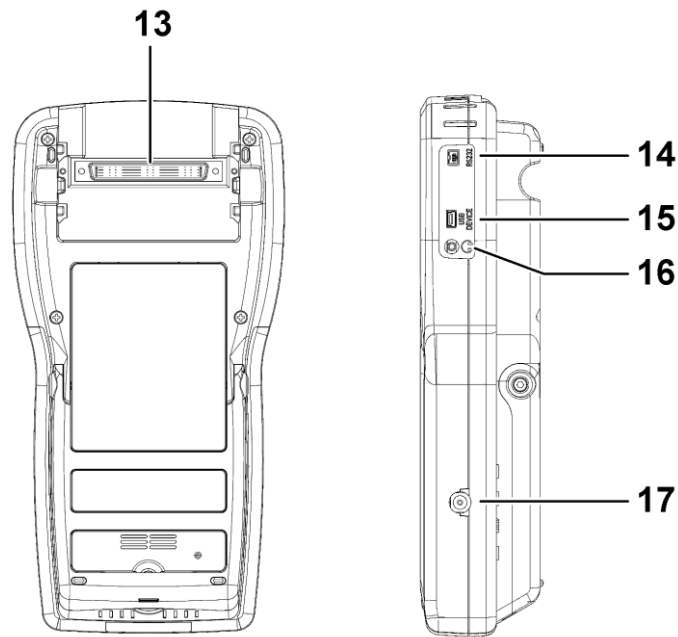

Illustration 1 2.2.1. The Remote Handset (RH)
Rear and side view

	Ports/Connectors	Description
13	Low-NEXT-Connector	Connect a test adapter.
14	Service and Maintenance Jack	Connection for service and maintenance work.
15	USB Device	Connect to a computer for firmware updates.
16	Talkset Jack	Connect a Talkset.
17	DC Input Jack	Connect an external power supply and charge battery pack.

2.3. Power Management

Both the Display (DH) and Remote (RH) handset use interchangeable rechargeable lithium-ion battery packs (Li-ion).

- The Display (DH) and Remote (RH) handsets can be run on battery power for approximately 18 hours. Actual battery power times depends on various factors, such as operating time versus standby time, use of the display backlight, and ambient temperature.
- When charge state of battery drops below the required voltage, a warning appears. Tester automatically shuts down before testing results are affected.
- To save battery power, the Display (DH) and Remote (RH) handset automatically power down after a certain period of inactivity.
- If the instrument will not be used for a prolonged time it is recommended that the battery protection strips be inserted to conserve battery charge.

2.3.1. Operating the Display and Remote handset from AC Power

The Display (DH) and Remote (RH) handset can also be operated from an external DC source (AC/DC adapter). The adapters are universally applicable.

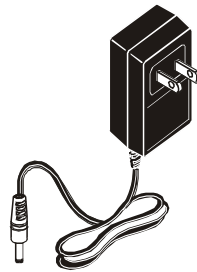

Illustration 2.3.1. Adapter for LanTEK® II DH and RH

When using the AC/DC adapter to power the handsets, please note that:

- Both handset batteries will receive a trickle charge.
- A power plug will appear in the upper left corner of the Display handset (DH).



CAUTION!

Only the adapter provided with the instrument shall be used. Other types of adapters may cause damage to the tester.

NOTE:

Do not connect to AC power when testing shielded cables, as this may result in ground loops which in turn can cause input protection warnings.

2.3.2. Battery Charging

The batteries of the Display (DH) and Remote (RH) handset are charged using the adapter. It takes approximately 6-8 hours until the batteries in the instrument are fully charged. If the batteries are charged externally, charge time is approximately 4 hours.

During recharging, the instrument is calibrated to the corresponding battery. This ensures an accurate indication of the charge state at all times.

NOTE:

Charge time depends on charge state of battery.

When the battery is removed, the Display handset (DH) data and preferences are preserved in the flash ROM by a coin cell lithium battery.

2.4. Talkset

The LanTEK®II Cable Certifier is designed for use with a talkset. This function allows communication between the Display (DH) and Remote (RH) handset through an externally attached microphone/headset. For this purpose, the Display (DH) and Remote (RH) handset must be connected to the test adapters through a cable.

3.1. Testing of cables and relevant requirements

The following sections describe typical setup for permanent link and channel link testing.

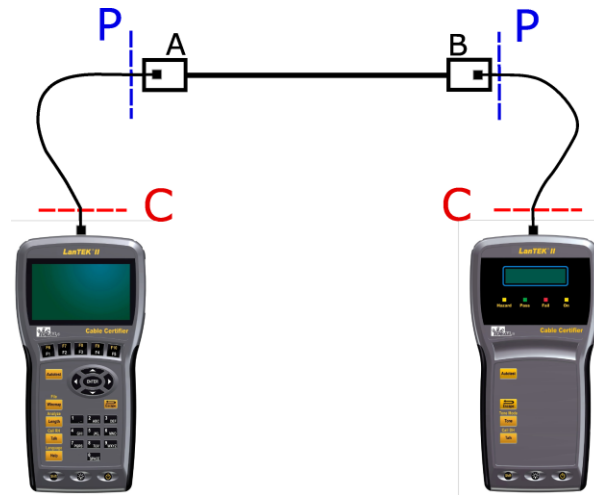

Illustration 3.1. Illustration of test setup

The area marked with **P** indicates the typical test setup of a **Permanent Link**.

The area marked with **C** indicates the typical test setup of a **Channel Link**.

3.1.2. Setup for Permanent Link Test

The standards ANSI, EIA, TIA and ISO all differentiate between permanent link and channel link on specifications for testing of communication networks. A permanent link consists of up to 90 meters of horizontal cabling. (Maximum length limit applies to TIA standards only.) The permanent link shown above serves to certify the installation of the horizontal cabling before network connection and user hook-up. Adapters, patch cords and jumpers are excluded from testing.

3.1.3. Setup for Channel Link Test

A channel link includes all components of a cabling system. It consists of up to 90 meters horizontal cabling, including patch cords, jumpers, and test adapters at each cable end. The channel link shown above serves to certify the network installation, including the horizontal cable line and patch cord.

Most instrument configurations are set by using the "Preferences" menu.

4.1. Open Preferences

1. Use **Arrow Keys** to navigate to "Preferences" and press **Enter**.

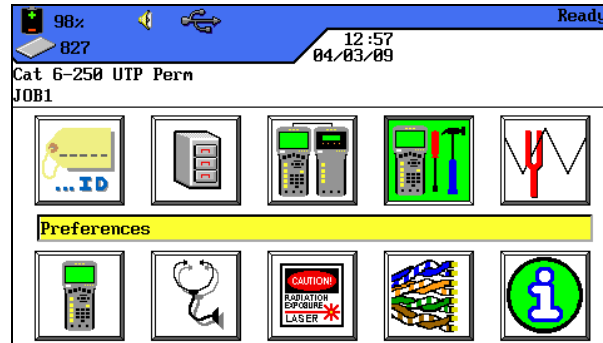

Illustration 1 4.1. Open Preferences

Next, the instrument preferences can be set by using the listed menus.

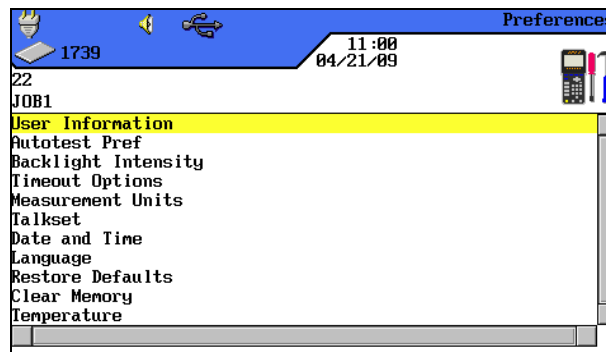

Illustration 2 4.1. Preference Selection

4.2. Language

Menu navigation of LanTEK®II Cable Certifier is available in the following languages:

Chinese	Korean
Czech	Norwegian
Dutch	Polish
English	Portuguese
French	Russian
German	Spanish
Italian	

1. Use **Arrow Keys** to navigate to "Language" menu and press **Enter**. Alternatively, open menu by using the **Shift + Help / Language** keys.

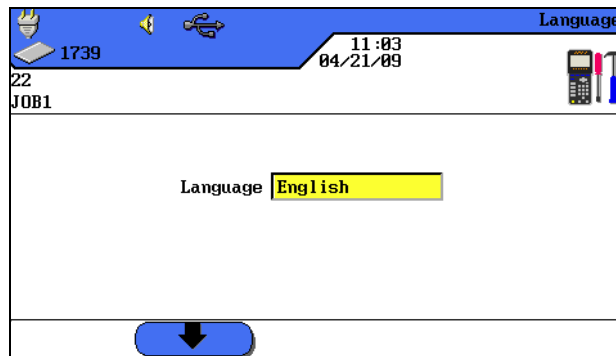



Illustration 4.2. Language

2. Use soft keys   to select the desired language.
3. Press **Enter** to save the information entered. **Escape** allows you to exit the menu without making changes.

4.3. User Information

This menu can be used to provide information on assigned Technician, Company and Contractor.

1. Use **Arrow Keys** to navigate to "User Information" menu and press **Enter**.

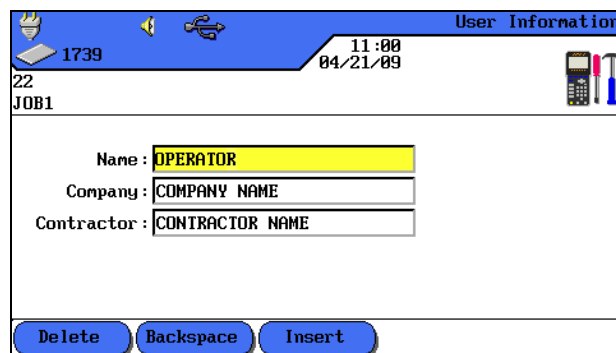





Illustration 4.3. User Information

2. Use **Arrow Keys** to navigate to desired option *Name*, *Company* or *Contractor*.
3. Use **Alphanumeric Keys** to enter the desired information.
4. Make corrections to entries by using the soft keys  (delete at cursor position),  (delete characters to the left of cursor),  /  (insert alphanumeric characters at cursor position / overwrite highlighted entry).
5. Press **Enter** to save the information entered. Press **Escape** to exit the menu without making changes.

4.4. Autotest Options

Use this menu to set **Autotest** options.

1. Use **Arrow Keys** to navigate to "Autotest Options" menu and press **Enter**.

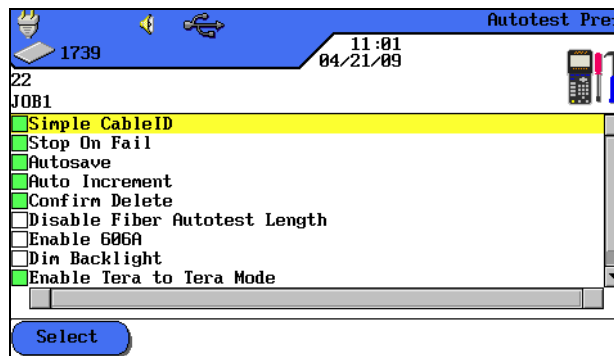

Illustration 4.4. Autotest Options

2. Use **Arrow keys** to select the desired option.
3. Use soft key **Select** to activate or deactivate the selected option. An activated option is indicated by the green box.
4. Press **Enter** to save the information entered. Press **Escape** to exit the menu without making changes.

4.5. Contrast

Use this menu to set Dim Backlight on screen.

1. Use **Arrow Keys** to navigate to "Contrast" menu and press **Enter**.

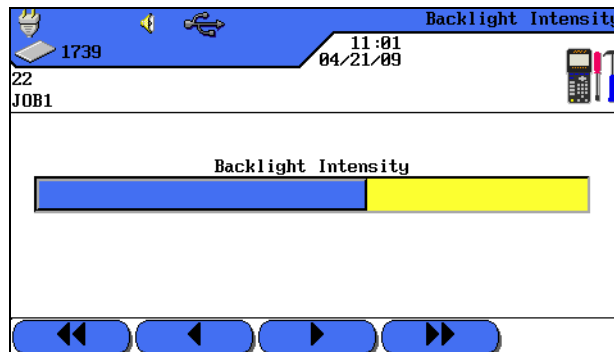

Illustration 4.5. Contrast

2. Use soft keys **Left Arrow**, **Right Arrow**, **Double Left Arrow**, and **Double Right Arrow** to set backlight intensity.
3. Press **Enter** to save the information entered. Press **Escape** to exit the menu without making changes.

4.6. Timeout Options

Use this menu to set the time after which backlight automatically dims and the LanTEK®II Cable Certifier automatically shuts down when tester is not in use.

Default settings:

Backlight	1 minute
Tester	30 minutes

1. Use **Arrow Keys** to navigate to "Timeout Options" menu and press **Enter**.

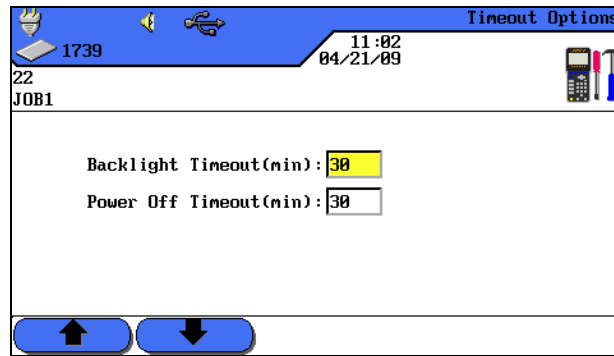



Illustration 4.6. Timeout Options

2. Use **Arrow keys** to select the desired option.
3. Use soft keys   to set the desired value.
4. Press **Enter** to save the information entered. Press **Escape** to exit the menu without making changes.

4.7. Measurement Units

Use this menu to specify the measurement unit for length measurements *ft* or *m* (foot or meter). The default setting depends on the language selected.

1. Use **Arrow Keys** to navigate to "Measurement Units" menu and press **Enter**.

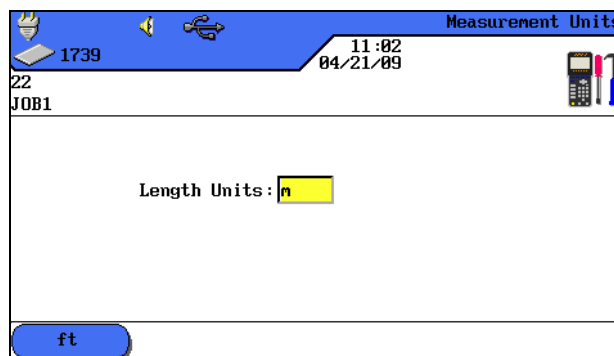



Illustration 4.7. Measurement Units

2. Use soft key  /  (foot / meter) to select the desired unit.
3. Press **Enter** to save the information entered. Press **Escape** to exit the menu without making changes.

4.8. Talkset

Use this menu to set signal strength of tone generator, volume of internal speaker and volume of talkset. Also use this menu to change the talkset mode.

1. Use **Arrow Keys** to navigate to "Talkset" menu and press **Enter**.

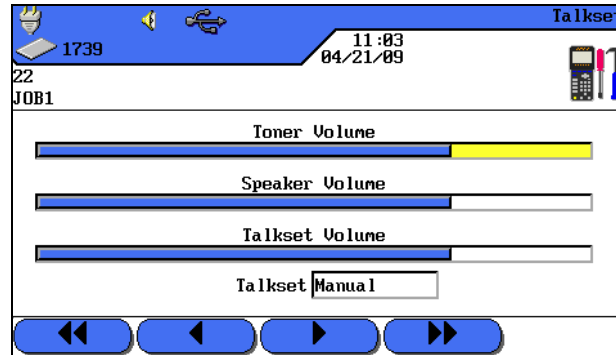





Illustration 4.8. Talkset

2. Use **Arrow Keys** to select the desired option.
3. On options *Toner Volume*, *Speaker Volume* or *Talkset Volume*, use soft keys   to set signal strength and volume.
4. On option *Talkset*, use soft key  /  to select desired setting.
5. Press **Enter** to save the information entered. Press **Escape** to exit the menu without making changes.

4.9. Date and Time

Accurate date and time settings are important for the reliable identification of records and test reports.

1. Use **Arrow Keys** to navigate to "Date and Time" menu and press **Enter**.

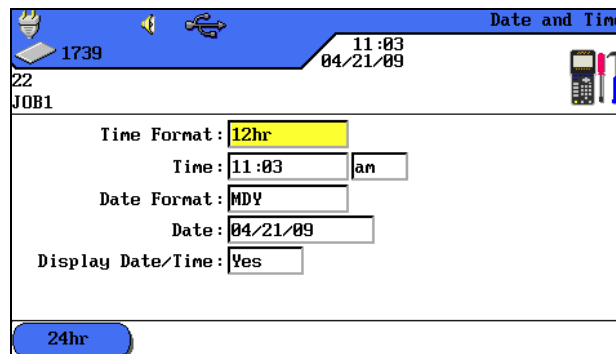
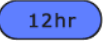







Illustration 4.9. Date and Time

2. Use soft key  /  to set the desired *Time format*.
3. Use **Arrow Keys** to navigate to option *Time*.
4. Use **Alphanumeric Keys** to enter the time.
5. Use **Arrow Keys** to navigate to option *Date Format*.

6. Use soft keys   to select the desired format *MDY* (month/day/year), *DMY* (day/month/year) or *YMD* (year/month/day).
7. Use **Arrow Keys** to navigate to option *Date*.
8. Use **Alphanumeric Keys** to enter the date.
9. Use **Arrow Keys** to navigate to option *Date/Time Display*.
10. Use soft key  /  to select the desired setting.
11. Press **Enter** to save the information entered. Press **Escape** to exit the menu without making changes.

4.10. Restore Default

Use this menu to reset all tester settings to their factory defaults. Using this option will not delete stored tests.

1. Use **Arrow Keys** to navigate to "Restore Defaults" menu and press **Enter**.

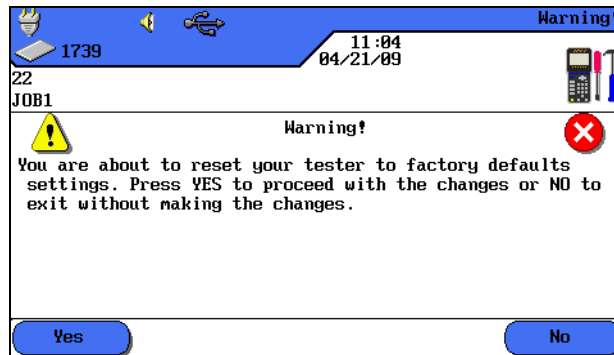



Illustration 4.10. Restore Defaults

2. Use the soft key  to accept default settings.
3. Use the soft key  to exit the screen without making changes.

4.11. Clear Memory

Use this menu to clear all records from the tester memory at one time.



CAUTION!

When using the "Clear Memory" menu, the records cannot be restored. This will permanently delete all stored tests.

1. Use **Arrow Keys** to navigate to *Clear Memory* menu and press **Enter**.

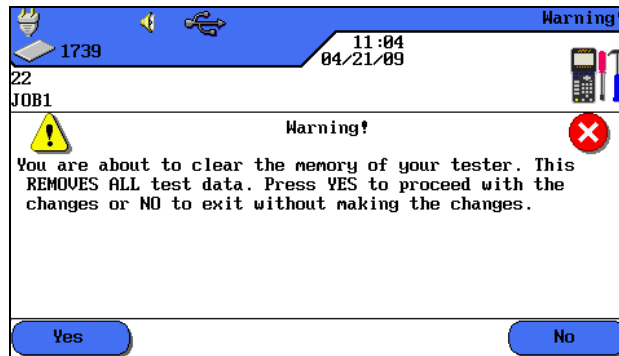



Illustration 4.11. Clear Memory

2. Use the soft key  to clear the memory of the Cable Certifier.
3. Use the soft key  to exit the screen without making changes.

4.12. Temperature

Use this menu to select the required temperature in *Celsius* or *Fahrenheit*.

1. Use **Arrow Keys** to navigate to "Temperature" menu and press **Enter**.

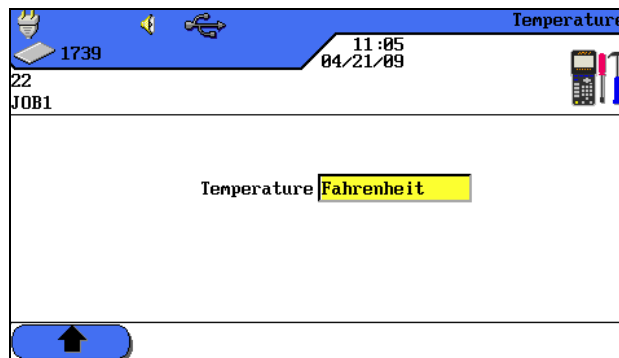



Illustration 4.12. Temperature

2. Use the soft keys   to select the desired temperature.
3. Press **Enter** to save the information entered. **Escape** allows you to exit the menu without making changes.

Using Autotest, the installation can be measured and tested in a simple and fast way. After pressing the **AUTOTEST** key, LanTEK®II Cable Tester automatically performs a number of pre-programmed single tests. Autotest can be enabled from the Display (DH) or Remote (RH) handset.

Selection of single tests from the test series depends on the type of cabling to be tested. Specification of the test series is based on approved or recommended standards, as well as specific parameters.

After the test series is completed, LanTEK®II Cable Tester displays an overall passed/failed result, as well as the individual passed/failed results.

Preferences on Display handset (DH)

- Set Autotest Pref.
- Select job folder.
- Set cable name (cable ID).
- Select cable type.

Connections

- Separate cable line to be tested from all network components.
- Using suitable patch cords, connect the Display handset (DH) to one end of the cable line (link), and the Remote handset (RH) to the opposite end of the cable line (link).

Test run

By pressing the **AUTOTEST** key, the test procedures described below are initiated:

- First, the Display handset (DH) attempts to establish a connection to the Remote handset (RH) via a correctly connected wire pair. If connection cannot be established, the Display handset (DH) will show the message "Searching for Remote (RH)". The search is continued until the Autotest is manually cancelled or the Remote handset (RH) is located.
- After connection to the Remote handset (RH) has been successfully established, its serial number is read out to check if current configuration data are available.

NOTE:

If during the last 7 days no calibration has been performed on the identified Remote handset (RH), the Autotest is cancelled and the user receives a message that a field calibration is required.

- Display handset (DH) continues the Autotest if serial number is valid. Most Autotests start with the Wiremap test for twisted pair cables.
- Following the Wiremap test, the other single tests that have been defined for the currently selected cable type are performed.
- After completion of Autotest, all test data can be displayed, saved and printed.
- The test results of the last Autotest are stored in the non-volatile memory and remain available for viewing even after the LanTEK®II Cable Tester is powered on or powered down.

- The test results of the last Autotest remain in the non-volatile memory until they are overwritten by new test results, the memory is deleted or an analysis test is conducted.

Overall Passed/Failed Result

The overall result of Autotest is displayed after test series is completed.

Symbol	Overall Autotest Result
✓	The overall Autotest receives a passing grade if all single tests have been passed or passed*.
✗	The overall Autotest receives a failing grade if at least one single test has failed or failed*.

5.1. Set Autotest Pref

1. Open "Preferences" on start screen.
2. In "Preferences" open *Autotest Pref*.
3. Use **Arrow Keys** to navigate to the according Autotest Pref. Use soft key **Select** to enable or disable the selected Autotest Pref. Enabled Autotest Pref are indicated by green boxes.

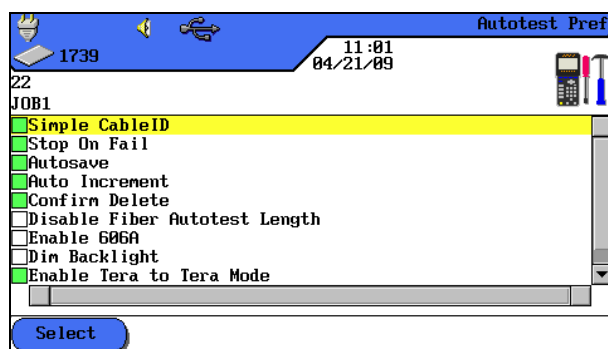

Illustration 5.1. Autotest Pref

4. Press **Enter** to save the information entered. **Escape** allows you to exit the menu without making changes.

Autotest Pref	Description
<i>Simple cable ID</i>	Assign name to cable line and set/reset meter reading of tests. The name can be assigned as simple cable ID or double cable ID (Cable From/Cable To). NOTE: If <i>Simple Cable ID</i> is <u>not</u> enabled, the cable name assigned will be the default cable ID. In addition to cable name and test meter, an initial value and a final value can be set, and the way of counting can be specified.
<i>Stop on Fail</i>	The Autotest is stopped after the first failed test.
<i>Autosave</i>	The LanTEK®II Cable Tester automatically names and saves all results of <u>passed Autotests</u> in the current job folder.
<i>Auto Increment</i>	The test meter for the cable ID is automatically advanced after each Autotest.

Autotest Pref	Description
<i>This will permanently delete the Tests / Jobs from the tester</i>	Enables confirmation prompt prior to deleting data.
<i>Disable Fiber Autotest Length</i>	Enable / disable length measurement of fiber (LWL) with FiberTEK™ FDX during Autotest.
<i>Enable 606A</i>	Enable labelling standard TIA/EIA 606-A for telecommunication infrastructure as cable ID. NOTE: If labelling standard TIA/EIA 606-A is enabled; the selected cable name (simple cable ID/default cable ID) is not applied.
<i>Enable Tera to Tera Mode</i>	Enables Tera to Tera Mode instead of Tera to RJ45 Mode.
<i>Enable Wiremap On Failed Autotest.</i>	In case of failed Autotest, it determines whether another fault analysis will automatically be performed.

5.2. Select Job Folder

The name of the current job folder is shown in the TFT display on the ready screen. To save the Autotest it is possible to keep this job folder, enable another existing job folder, or create a new job folder.

5.2.1. Enable Existing Job Folder

1. Use **Arrow keys** to navigate to "File" and press **Enter** to open the job list.

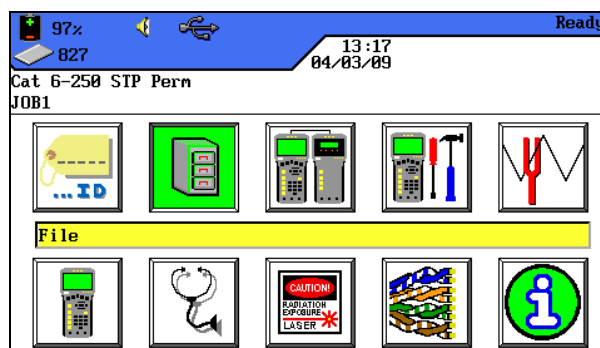

Illustration 1 5.2.1. File

Use **Arrow Keys** to navigate to the desired job folder. The display is highlighted **yellow**.



Illustration 2 5.2.1. Job List

2. Use soft key **Options** to open job options.
3. Use **Arrow Keys** to navigate to option *Make Job Current*. The display is highlighted **yellow**.

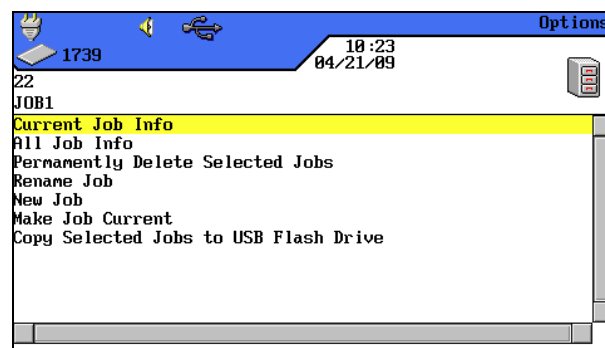

Illustration 3 5.2.1. Job Options (example Current Job Info)

4. Press **Enter** to save the information entered. **Escape** allows you to exit the menu without making changes.
5. When confirming with **Enter**, the name of the selected job folder will appear on the ready screen.

5.2.2. Create New Job Folder

1. Use soft key **Options** to open job options in job list.

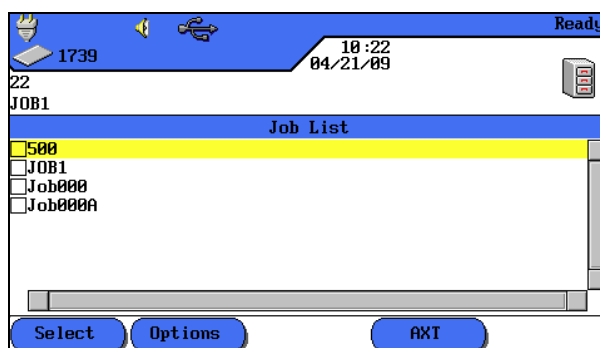

Illustration 1 5.2.2. Job List

2. Use **Arrow Keys** to navigate to option *New Job* and press **Enter**.

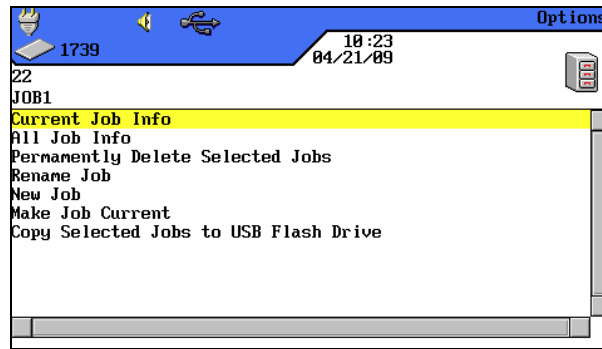

Illustration 2 5.2.2. Job Options

3. Use **Alphanumeric Keys** to enter the desired information.

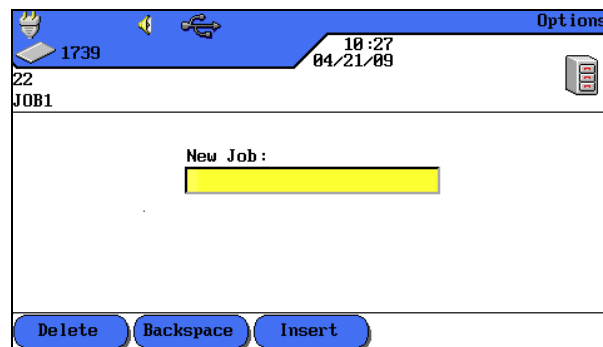

Illustration 3 5.2.2. New Job

4. Make corrections to entries by using the soft keys **Delete** (delete at cursor position), **Backspace** (delete characters to the left of cursor), **Insert** / **Overwrite** (insert alphanumeric characters at cursor position / overwrite highlighted entry).
5. Press **Enter** to save the information entered. **Escape** allows you to exit the menu without making changes.
6. When confirming with **Enter**, the name of the new job folder will appear on the ready screen.

5.3. Set Cable Name (cable ID)

The cable name of the cable lines in an Autotest consists of a fixed *Cable Name* and a variable *Current Value* (4-digit test meter) that automatically increments. Depending on selected Autotest Pref it is also possible to specify structure and way of counting.

1. Use **Arrow keys** to navigate to "Cable ID" and press **Enter**.

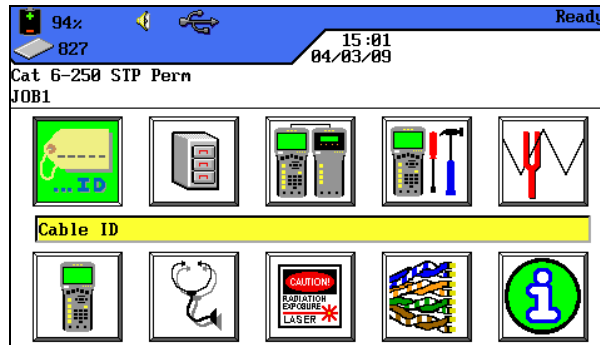

Illustration 5.3. Cable ID

The name used last will appear:

- *Single Cable ID* (1 name is assigned to each cable).
- or
- *Double Cable ID* (2 names are assigned to each cable, one for the start and one for the end of the cable).

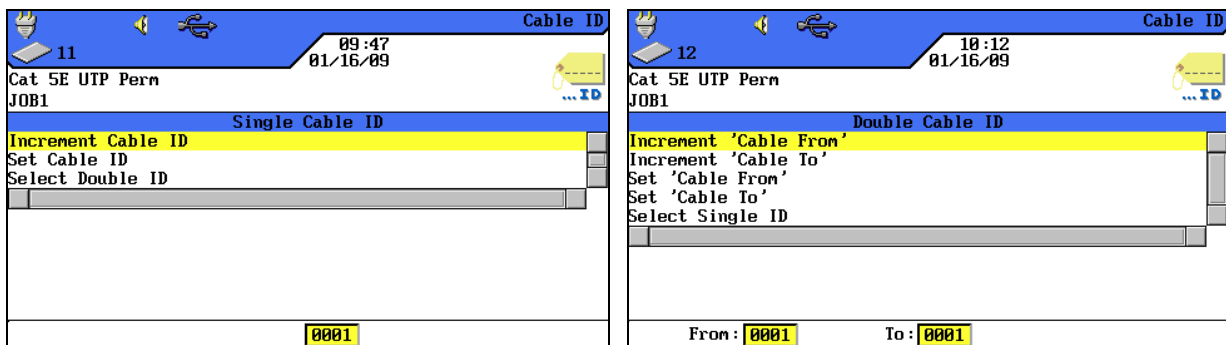

Illustration 5.3. Cable ID

- *Increment...* when pressing **Enter**, the current value of the test meter, shown in view below, is incremented by one position.
- *Set...* opens menu for cable name.
- *Select...* switches between *Single Cable ID* and *Double Cable ID*.

5.3.1. Simple Cable ID

- Use **Arrow keys** to navigate in "Cable ID" view to option *Set...* and press **Enter**.

Single Cable ID (1 cable name)

- Use **Alphanumeric Keys** to enter a *Cable Name* for the test portion.
- Use **Alphanumeric Keys** to reset the *Current Value* of the test meter, or enter an arbitrary value.
- Make corrections to entries by using the soft keys **Delete** (delete at cursor position), **Backspace** (delete characters to the left of cursor), **Insert** / **Overwrite** (insert alphanumeric characters at cursor position / overwrite highlighted entry).

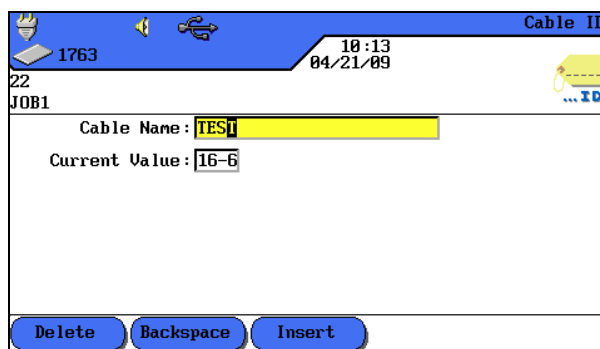

Illustration 1 5.3.1. Single Cable ID

- Press **Enter** to save the information entered. **Escape** allows you to exit the menu without making changes.

Double Cable ID (2 cable names, start/end)

- Use **Alphanumeric Keys** to enter a *Cable Name* for the *Cable From/Cable To* of test portion.
- Use **Alphanumeric Keys** to reset the *Current Value* of the test meter, or enter an arbitrary value.
- Make corrections to entries by using the soft keys **Delete** (delete at cursor position), **Backspace** (delete characters to the left of cursor), **Insert** / **Overwrite** (insert alphanumeric characters at cursor position / overwrite highlighted entry).

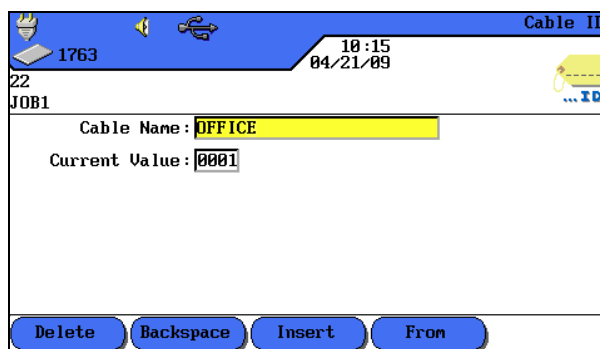



Illustration 2 5.3.1. Double Cable ID

- Use soft keys **From** and **To** to switch between the views *Cable From* and *Cable To*.

11. Use **Alphanumeric Keys** to enter a *Cable Name* for the *Cable From/Cable To* of test portion.
12. Use **Alphanumeric Keys** to reset the *Current Value* of the test meter, or enter an arbitrary value.
13. Make corrections to entries by using the soft keys **Delete** (delete at cursor position), **Backspace** (delete characters to the left of cursor), **Insert** / **Overwrite** (insert alphanumeric characters at cursor position / overwrite highlighted entry).
14. Press **Enter** to save the information entered. **Escape** allows you to exit the menu without making changes.

5.3.2. Default Cable ID

Simple cable ID was not selected in Autotest Pref.

1. Use **Arrow keys** to navigate in "Cable ID" view to option *Set...* and press **Enter**.
Simple Cable ID (1 cable name)
2. Use **Alphanumeric Keys** to enter a *Cable Name* for the test portion.
3. Use **Alphanumeric Keys** to reset the *Current Value* of the test meter, or enter an arbitrary value.
4. Use **Alphanumeric Keys** to enter an arbitrary value for *Start* and *End*. Meter is reset after reaching final value.
5. Make corrections to entries by using the soft keys **Delete** (delete at cursor position), **Backspace** (delete characters to the left of cursor), **Insert** / **Overwrite** (insert alphanumeric characters at cursor position / overwrite highlighted entry).
6. Use symbol  to lock a position into entered value. Use symbol  to enable Auto Increment of a character.

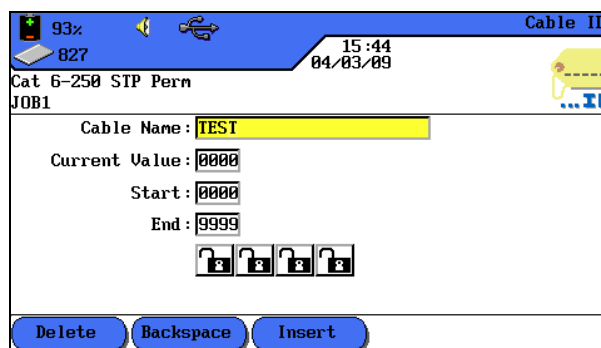



Illustration 1 5.3.2. Single Cable ID

7. Press **Enter** to save the information entered. **Escape** allows you to exit the menu without making changes.

Double Cable ID (2 cable names, start/end)

1. Use **Alphanumeric Keys** to enter a *Cable Name* for the *Cable From/Cable To* of test portion.
2. Use **Alphanumeric Keys** to reset the *Current Value* of the test meter, or enter an arbitrary value.

3. Use **Alphanumeric Keys** to enter an arbitrary value for *Start* and *End*. Meter is reset after reaching final value.
4. Make corrections to entries by using the soft keys **Delete** (delete at cursor position), **Backspace** (delete characters to the left of cursor), **Insert** / **Overwrite** (insert alphanumeric characters at cursor position / overwrite highlighted entry).
5. Use symbol  to lock a position into entered value. Use symbol  to enable Auto Increment of a character.

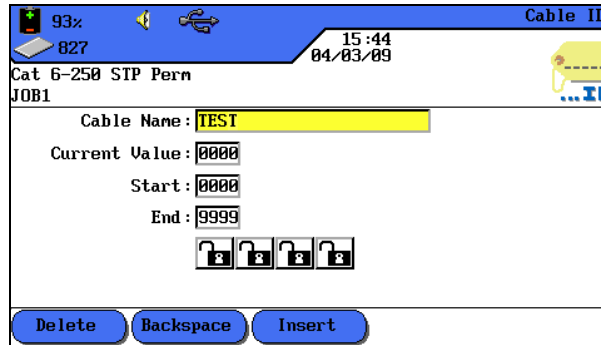









Illustration 2 5.3.2. Double Cable ID

6. Use soft keys **From** and **To** to switch between the views *Cable From* and *Cable To*.
7. Use **Alphanumeric Keys** to enter a *Cable Name* for the *Cable From/Cable To* of test portion.
8. Use **Alphanumeric Keys** to reset the *Current Value* of the test meter, or enter an arbitrary value.
9. Use **Alphanumeric Keys** to enter an arbitrary value for *Start* and *End*. Meter is reset after reaching final value.
10. Make corrections to entries by using the soft keys **Delete** (delete at cursor position), **Backspace** (delete characters to the left of cursor), **Insert** / **Overwrite** (insert alphanumeric characters at cursor position / overwrite highlighted entry).
11. Use symbol  to lock a position into entered value. Use symbol  to enable Auto Increment of a character.
12. Press **Enter** to save the information entered. **Escape** allows you to exit the menu without making changes.

Examples for Default Cable ID

In default setting, the meter starts at 0000 and ends at 9999. The four (4) positions are enabled and incrementing.

Default	Example 1	Example 2	Example 3	
			"Cable From"	"Cable To"
Cable name: TEST Current: 0 0 0 0 Start: 0 0 0 0 End: 9 9 9 9 	Cable name: PANEL 1 Current: 0 0 0 0 Start: 0 0 0 0 End: 0 0 2 2 	Cable name: PANEL 2 Current: 0 1 8 A Start: 0 0 0 A End: 0 9 9 D 	Cable name: OFFICE 2 Current: 0 0 0 0 Start: 0 0 0 0 End: 9 9 9 9 	Cable name: Distributor Current: 0 0 0 A Start: 0 0 0 A End: 0 0 9 D 
0 0 0 0	0 0 0 0	0 1 8 A	0 0 0 0	0 0 0 A
0 0 0 1	0 0 0 1	0 1 8 B	0 0 0 1	0 0 0 B
0 0 0 2	0 0 0 2	0 1 8 C	0 0 0 2	0 0 0 C
0 0 0 3	0 0 1 0	0 1 8 D	0 0 0 3	0 0 0 D
0 0 0 4	0 0 1 1	0 1 9 A	0 0 0 4	0 0 1 A
0 0 0 5	0 0 1 2	0 1 9 B	0 0 0 5	0 0 1 B
0 0 0 6	0 0 2 0	0 1 9 C	0 0 0 6	0 0 1 C
0 0 0 7	0 0 2 1	0 1 9 D	0 0 0 7	0 0 1 D
0 0 0 8	0 0 2 2	0 2 0 A	0 0 0 8	0 0 2 A
0 0 0 9	0 0 0 0	0 2 0 B	0 0 0 9	0 0 2 B
0 0 1 0	0 0 0 1	0 2 0 C	0 0 1 0	0 0 2 C
0 0 1 1	0 0 0 2	0 2 0 D	0 0 1 1	0 0 2 D
0 0 1 2	0 0 1 0	0 2 1 A	0 0 1 2	0 0 3 A

5.4. Labeling Standard TIA/EIA 606-A

The standards TIA/EIA 606-A for telecommunication infrastructure include the following elements:

- Horizontal cable arrangements and cabling.
- Backbone cable arrangements and cabling.
- Grounding/potential equalization for telecommunication systems.
- Rooms (e.g. service connection room, telecommunication room, equipment
- Room and fire protection installations.

The mentioned standards affect the administration of telecommunication infrastructure by:

- Assigning identifiers to infrastructure components.
- Specifying information elements on which the infrastructure is based.
- Specifying the relation between these records to ensure the contents.
- Specifying reports that contain information on record groups and
- Specifying the requirements on graphs and symbols.

5.4.1. Cable Name in Format TIA/EIA 606A

To determine cable name, a structure for the test portion is created. The three (3) cable parameters 606A Drop, 606A Backbone and 606A Backbone Pair/Fiber are available.

1. Use **Arrow keys** to navigate to "Cable ID" and press **Enter**.

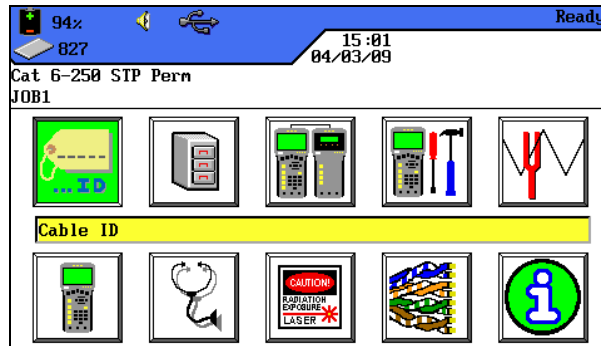

Illustration 5.4. Cable ID

5.4.2. Cable Parameter 606A Drop

Name of horizontal cable line (e.g. 1 building, 1 floor, 1 distribution, sockets)

2. Use soft key **Drop** to select cable parameter 606A Drop.

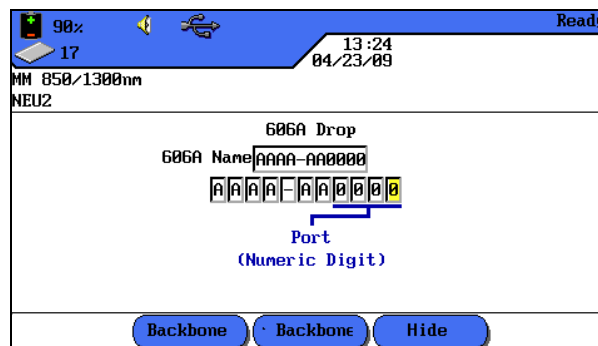

Illustration 1 5.4.2. Cable Parameter 606A Drop

AAA	A	-	AA	0000
Floor	Telecom room		Panel	Port

3. Use **Left/Right Arrow Keys** to navigate to desired position in port area. Use **Up/Down Arrow Keys** to assign characters and numbers.
4. Proceed in the same manner with positions **Panel**, **Telecom Room** and **Floor**.
5. Use soft key **Hide** to hide individual positions. Assembling the cable line automatically generates the *606A-Name*.
6. Press **Enter** to save the cable name. Use **Escape** to exit menu without making changes.

5.4.3. Cable Parameter 606A Backbone

Name of a horizontal and vertical cable line (e.g. several floors, several distributions, sockets).

1. Use soft key **Backbone** to select cable parameter 606A Backbone.

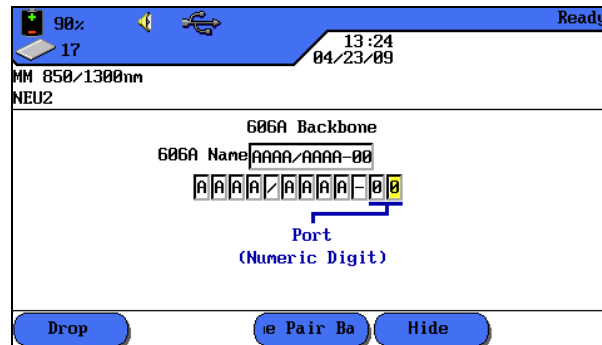

Illustration 1 5.4.3. Cable Parameter 606A Backbone

AAA	A	/	AAA	A	-	00
Floor	Telecom room		Floor	Telecom room		Port

2. Use **Left/Right Arrow Keys** to navigate to desired position in port area. Use **Up/Down Arrow Keys** to assign characters and numbers.
3. Proceed in the same manner with positions **Telecom Room** and **Floor**.
4. Use soft key **Hide** to hide individual positions. Assembling the cable line automatically generates the *606A-Name*.
5. Press **Enter** to save the cable name. Use **Escape** to exit menu without making changes.

5.4.4. Cable Parameter 606A Backbone Pair/Fiber

Name of a horizontal and vertical cable line with a pair/fiber connection (e.g. building, several floors, several distributions, sockets).

1. Use soft key **B Paar** to select cable parameter 606A Backbone Pair/Fiber.



Illustration 1 5.4.4. Cable Parameter 606A Backbone Pair/Fiber

AAA	A	/	AAA	A	-	00	.	000
Floor	Telecom room		Floor	Telecom room		Port		Pair

2. Use **Left/Right Arrow Keys** to navigate to desired position in **Pair** area. Use **Up/Down Arrow Keys** to assign characters and numbers.
3. Proceed in the same manner with positions **Port**, **Telecom Room**, and **Floor**.
4. Proceed in the same manner with positions **Telecom Room** and **Floor**.
5. Use soft key **Hide** to hide individual positions. Assembling the cable line automatically generates the *606A-Name*.
6. Press **Enter** to save the information entered. **Escape** allows you to exit the menu without making changes.

5.5. Select Twisted Pair Cabling

1. Open "Cable Type" on start screen.
2. Use **Arrow Keys** to navigate to installation type of cable line to be tested (*Twisted Pair Perm*, *Twisted Pair Basic* or *Twisted Pair Channel*) and confirm with **Enter**.

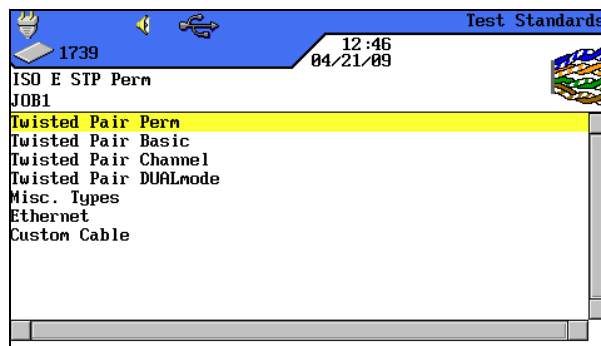

Illustration 1 5.5. Cable Type

3. Use **Arrow Keys** to navigate to desired cable type.

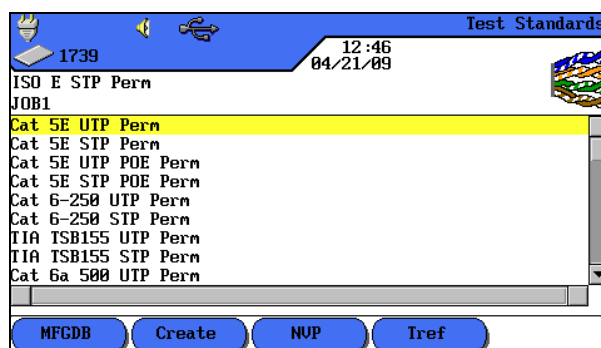

Illustration 2 5.5. Example Twisted Pair Perm

4. Press **Enter** to save the information entered. **Escape** allows you to exit the menu without making changes.

Or

5. Use available soft key options to specify a cable type, create a cable type, edit NVP values or enter reference temperature.

5.5.1. Specify Cable Type

1. Use soft key **MFGDB** to open select menu to specify the selected cable type.
2. Use **Arrow keys** to navigate to desired specification and confirm with **Enter**.

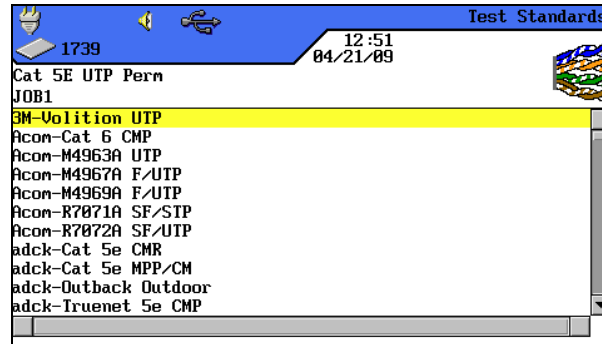

Illustration 5.5.1. Specification of Cable Type

3. Press **Enter** to save the information entered. **Escape** allows you to exit the menu without making changes.

5.5.2. Create Cable Type

1. Use soft key **Create** to open select menu for individual creation of a cable type.
2. Use **Arrow keys** in Select Menu to navigate to option *Frequency Range* and confirm with **Enter**.

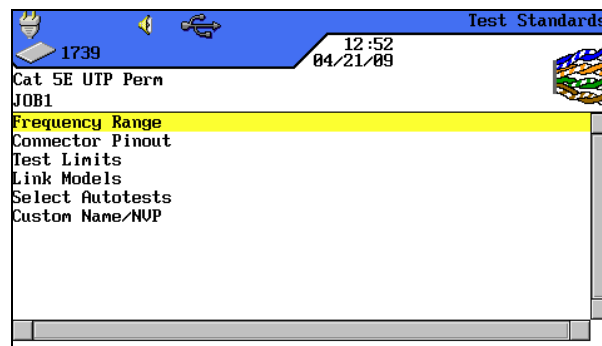

Illustration 1 5.5.2. Select Menu

3. Use **Arrow Keys** to navigate to the individual boxes and use **Alphanumeric Keys** to assign start and stop frequencies for *Certification* and *Performance Range*.

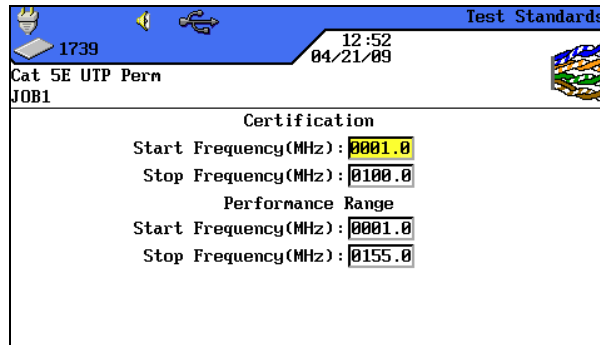

Illustration 2 5.5.2. Frequency range

4. Press **Enter** to save the information entered. **Escape** allows you to exit the menu without making changes.
5. Use **Arrow keys** in Select Menu to navigate to option *Connector Pinout* and confirm with **Enter**.
6. Use **Arrow keys** to navigate to desired pairings and enable or disable your selection with soft key **Select**. An enabled pairing is indicated by the green box.

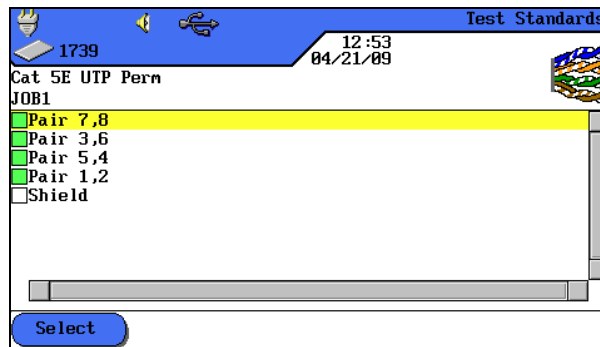

Illustration 3 5.5.2. Connector Pinout

7. Press **Enter** to save the information entered. **Escape** allows you to exit the menu without making changes.
8. Use **Arrow keys** in Select Menu to navigate to option *Test Limits* and confirm with **Enter**.
9. Use **Arrow keys** to navigate to the individual boxes and assign desired limit with the **Alphanumeric Keys**.

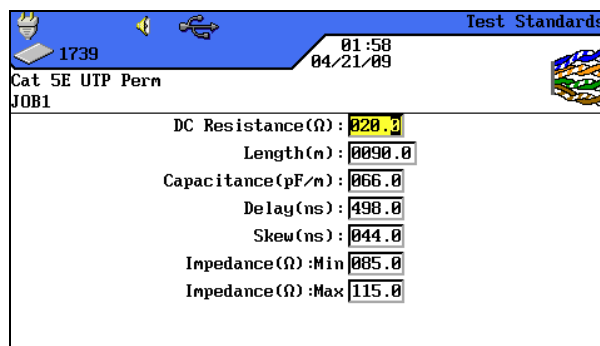



Illustration 4 5.5.2. Test Limits

10. Press **Enter** to save the information entered. **Escape** allows you to exit the menu without making changes.
11. Use **Arrow keys** in Select Menu to navigate to option *Link Models* and confirm with **Enter**.
12. Use soft key  to select the link model *Perm, Basic, Channel, EIA, Flat Rate, Ignore or Skip*.

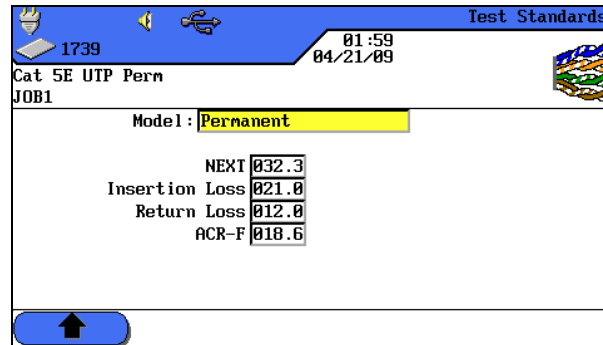



Illustration 5 5.5.2. Link Models

13. Use **Arrow Keys** to navigate to the individual boxes and use **Alphanumeric Keys** to assign the values for *NEXT, Insertion Loss, Return Loss* and *ACR-F (ELFEXT)*.
14. Press **Enter** to save the information entered. **Escape** allows you to exit the menu without making changes.
15. Use **Arrow keys** in Select Menu to navigate to option *Select Autotest* and confirm with **Enter**.
16. Prepare the desired measuring modes for the Autotest by using **Arrow Keys** to navigate to the desired measuring modes. Enable or disable your selection with soft key . An enabled measuring mode is indicated by the green box.

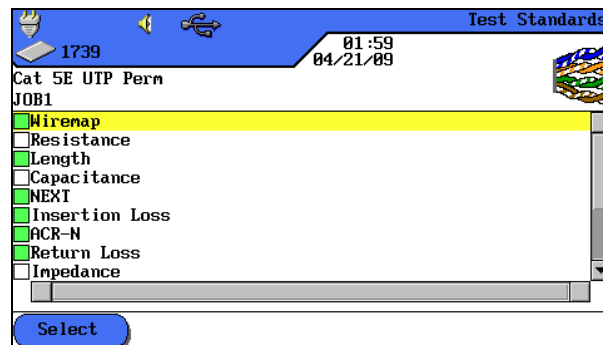

Illustration 6 5.5.2. Select Autotests

17. Press **Enter** to save the information entered. **Escape** allows you to exit the menu without making changes.
18. Use **Arrow keys** in Select Menu to navigate to option *Custom Name/NVP* and confirm with **Enter**.
19. Use **Alphanumeric Keys** to assign a name for the created cable type.

20. Make corrections to entries by using the soft keys **Delete** (delete at cursor position), **Backspace** (delete characters to the left of cursor), **Insert** / **Overwrite** (insert alphanumeric characters at cursor position / overwrite highlighted entry).

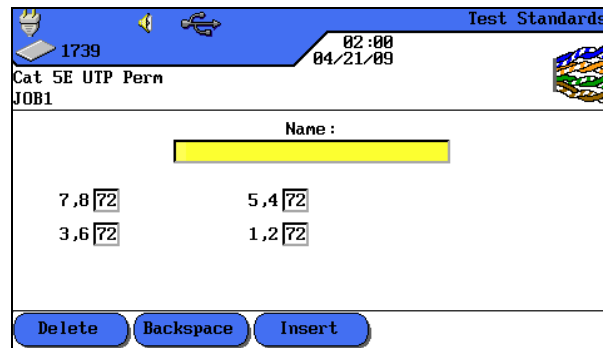

Illustration 7 5.5.2. Custom Name/NVP

21. Use **Arrow keys** to navigate to the individual boxes and assign desired NVP with the **Alphanumeric Keys**.
22. Press **Enter** to save the information entered. **Escape** allows you to exit the menu without making changes.

5.5.3. Edit and Calculate NVP

1. Use soft key **NVP** to open Select Menu for editing and calculating NVP.
2. Use **Arrow keys** to navigate to the individual boxes and assign desired NVP with the **Alphanumeric Keys**.

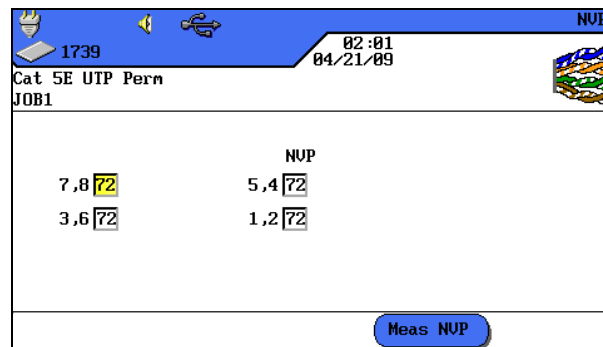

Illustration 1 5.5.3. NVP

3. Use soft key **Meas NVP** to open menu for entering cable length.
4. Use **Arrow Keys** to navigate to box and use **Alphanumeric Keys** to assign *Cable Length (m)*.
5. Connect cable to be tested.

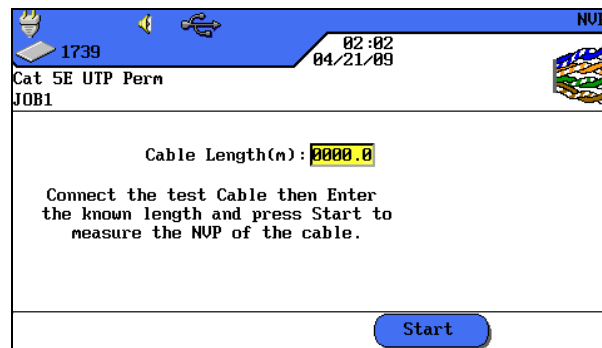

Illustration 2 5.5.3. Cable Length

6. Use soft key **Start** to start calculation of NVP.
7. Press **Enter** to save NVP. Use **Escape** to exit menu without making changes.

5.5.4. Enter Reference Temperature

1. Use soft key **Tref** to open Select Menu for changing ambient temperature.
2. Use **Alphanumeric Keys** to assign reference temperature.

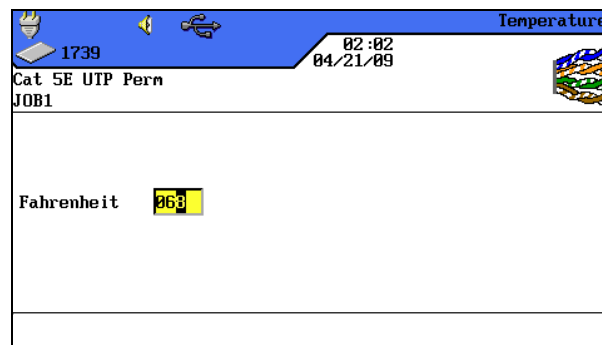

Illustration 5.5.4. Reference Temperature

3. Press **Enter** to save the reference temperature. Use **Escape** to exit menu without making changes.

5.6. DualMODE™ Function for Twisted Pair Cabling

The DualMODE™ function of LanTEK®II Cable tester allows measurement in compliance with 2 limits in one single Autotest. Thus, for instance, simultaneous Channel Link and Permanent Link measurements can be performed.

With DualMODE™ it is possible to perform other important tests. Let us assume you are installing a Cat-6 system in a country whose government agency uses a national standard based on ISO. But you are working with cables and connection components manufactured by a company in the US. The government agency can request a certification according to ISO Class E from the installer. However, for warranty reasons the US company might insist on TIA 568 Category 6. Therefore, in the past both certifications were required - in compliance with ISO and TIA - and the increased costs had to be passed on to the customer. In contrast, DualMODE™ makes it possible to perform both certifications at the same time, in compliance with ISO Class E Permanent Link and TIA 568B Category 6. The costs are the same as for one test.

Another example for the use of DualMODE™ is the calculation of margins in relation to higher bandwidth for future applications. Up to now you had to check the certification documents for Category 6 Permanent Link and assess whether adequate margins for transmission of applications at higher bandwidth are available. However, assessment of the complete final data would also require a certification according to Category 6_A. Due to higher test costs, these measures would usually not be performed.

With DualMODE™ you can certify the system in compliance with Category 6, and perform tests with the limits of Category 6_A. Due to unmistakable data, your customer would know exactly what cable lines support higher bandwidths in future applications. This information would be of great importance when making a decision on whether to assemble cables with connectors of a higher category, or to pull in cables of a higher category.

5.6.1. Implement DualMODE™

1. Open "Cable Type" on start screen.
2. Use **Arrow Keys** to navigate to function *Twisted Pair DualMODE™* and confirm with **Enter**.

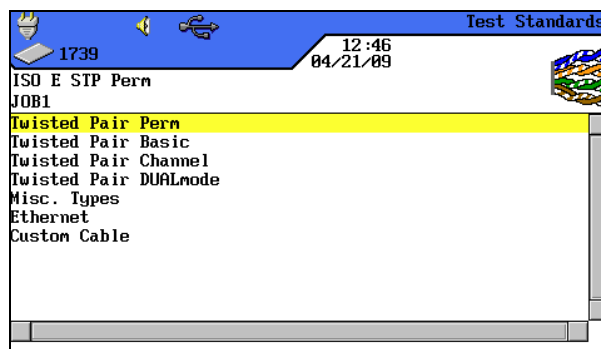

Illustration 1 5.6.1. Twisted Pair DualMODE™

3. Use **Arrow Keys** to navigate to desired cable types. Use soft key **Select** to enable, and soft key **Deselect All** to disable your selection. An enabled pairing is indicated by the green box.
4. If you would like another link model, or edit and calculate NVP for the DualMODE™ pairing, press **Shift**.

- Press **AUTOTEST**. The passed/failed results are displayed. For each DualMODE™ test, the worst case margins and values for NEXT, RL, ACR und Loss are indicated.

Value	Parameter	Value
6.3	Margin	7.7
7.3	NEXT	8.6
9.5	Return Loss	10.4
17.4	ACR-N	19.8
	Insertion Loss	

Illustration 2 5.6.1. Overall DualMODE™ Result

- Use **Enter** to load the corresponding graphical result displays of the highlighted test.

5.7. Edit NVP Default Value of a Cable

To perform length measurement, the nominal velocity of propagation (NVP) of the cable must be known. This value can be found in the technical cable information. If this information is not available, a cable of known length (ca. 30 – 60 meter) should be connected, and the NVP calculated by LanTEK®II Cable Tester.

- Open "Cable Type" on start screen.
- Use **Arrow Keys** to navigate to desired cable type.

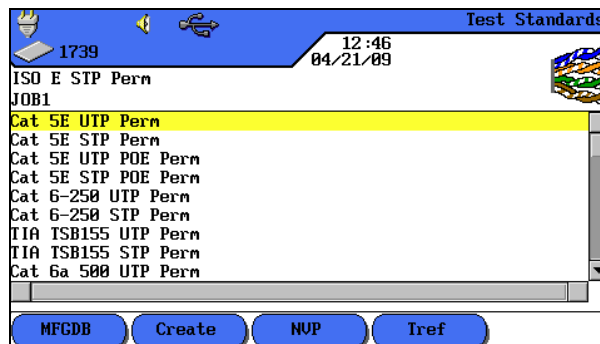

Illustration 1 5.7. NVP Default Value

- Use soft key **NVP** to open menu for entering NVP.

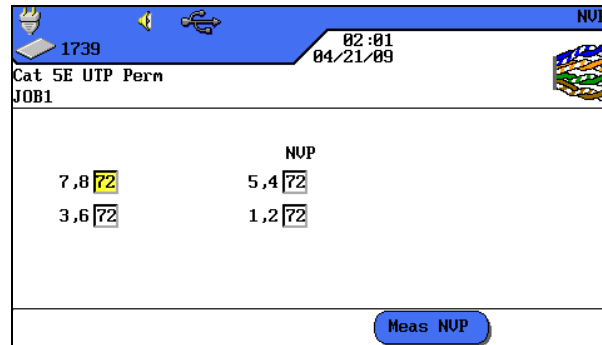

Illustration 2 5.7. Enter NVP

4. Use **Alphanumeric** keys to enter one or several NVP.
5. For automatic calculation of a new NVP, press **Meas NVP**.

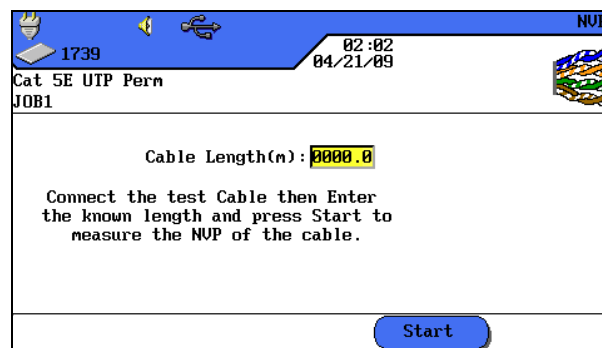

Illustration 3 5.7. Calculation of NVP

6. Connect a cable of known length.
7. Use **Arrow Keys** and **Number Keys** to enter known cable length.
8. For automatic calculation of a new NVP, press **Start**. After calculation of new NVP, the display returns to the NVP main screen.

NOTE:

This concerns a channel measurement. When entering the cable length, the length of both patch cords must be considered.

5.8. Coaxial Cable Standards

The LanTEK®II Cable Tester supports the following coaxial cable standards:

CATV standards	Ethernet standards	Other cable types
RG59 31 or 92 m (3-fold or 4-fold shield)	10Base 2	IBM Coax
RG6 31 or 92 m (3-fold or 4-fold shield)	10Base 5	TWINAXIAL
		ARCNET

1. Open "Cable Type" on start screen.

2. Use **Arrow Keys** to navigate to option *Ethernet* and confirm with **Enter**.

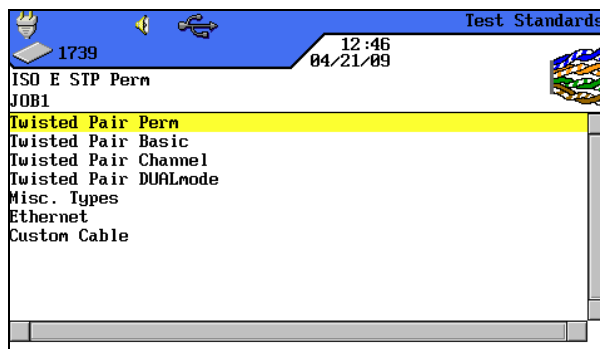

Illustration 1 5.8. Ethernet

3. Use **Arrow Keys** to navigate to desired cable type and confirm with **Enter**.

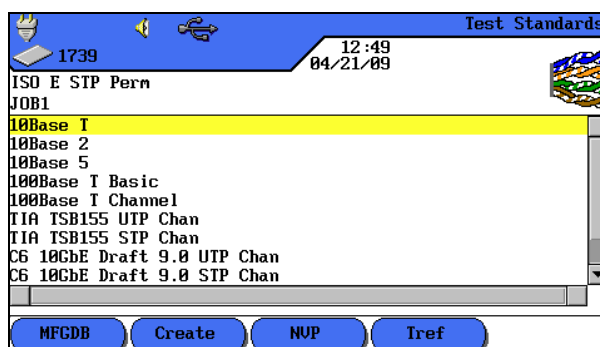

Illustration 2 5.8. Cable Type

5.8.1. Autotest Test Series for Coaxial Cables

Cable Types	Resistance	Length	Loss	Return loss	Impedance
RG59 31 or 92 m	X	X	X	X	X
RG6 31 or 92 m	X	X	X	X	X
IBM Coax	X	X	X		
TWINAX, ARCNET	X	X	X		
10BASE2 (IEEE 802.3)	X	X	X		
10BASE5 (IEEE 802.3)	X	X	X		

5.9. Calibration

A field calibration must be performed if:

- During the last 7 days no calibration has been performed. The user receives a message, informing him that a field calibration is required.
- The test adapter has been changed.
- A patch cord has been changed.

5.9.1. Twisted Pair Cabling

1. Use **Arrow Keys** to navigate to "Calibration" and press **Enter** to open job list.



Illustration 1 5.9.1. Ready screen

Calibration requires one patch cord each for the Display handset (DH) and the Remote handset (RH).

NOTE:

It is imperative not to mix up the corresponding patch cords for Display handset (DH) and Remote handset (RH), and they must also be used for the cable test. We recommend to mark the patch cords accordingly.

2. Connect Display handset (DH) and Remote handset (RH) with patch cord for Remote handset (RH), as shown on the display. Remember which connection of the patch cord is connected to the Remote handset (RH).

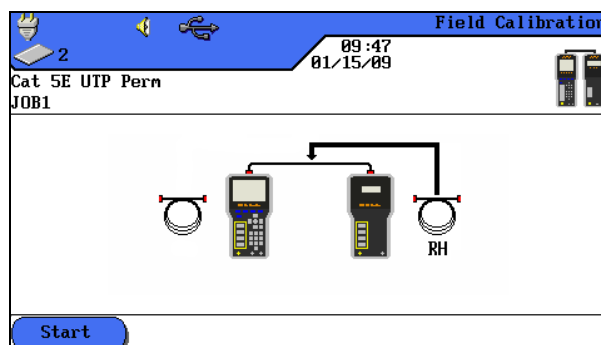

Illustration 2 5.9.1. Patch Cord (RH)

3. Use soft key **Start** to initiate calibration. The Remote handset (RH) indicates calibration, and a progress bar shows the status.

4. Connect Display handset (DH) and Remote handset (RH) with patch cord for Display handset (DH), as shown on the display. Remember which connection of the patch cord is connected to the Display handset (DH).

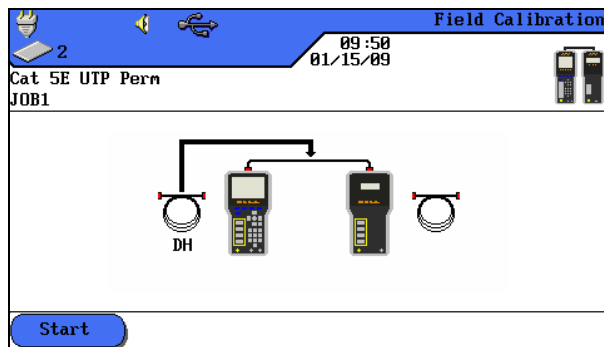

Illustration 3 5.9.1. Patch Cord (DH)

5. Use soft key **Start** to continue calibration. The Remote handset (RH) indicates calibration, and a progress bar shows the status.
6. Perform the same patch cord connections to Display handset (DH) and Remote handset (RH) as during the previous test steps.

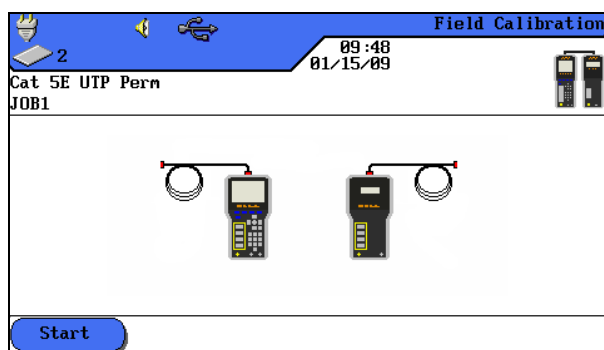

Illustration 5.9. Open Patch Cord

7. On Display handset (DH) use soft key **Start** to start the last step of calibration.
8. On Remote handset (RH) use **Autotest** to start the last step of calibration.

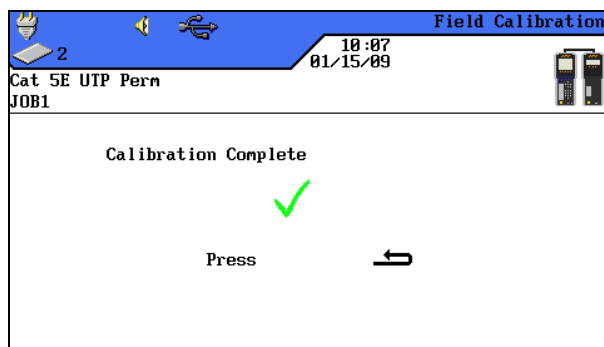

Illustration 4 5.9.1. Calibration Complete

9. On Display handset (DH) press **Escape** to return to screen. The Remote handset (RH) briefly displays that calibration was successful, and then shows ready state.

5.9.2. Coaxial Cable

Calibration must be performed if:

- During the last 7 days no calibration has been performed. The user receives a message, informing him that a field calibration is required.
- The test adapter has been changed.
- A patch cord has been changed.

For calibration with COAX adapters, the LanTEK®II process, consisting of 4 steps, is changed. Since the coaxial cables are tested at low frequencies, the additional data received during calibration are largely ignored, thus calibration with LanTEK®II Cable Tester is already completed after one step.

NOTE:

The LanTEK®II Cable Tester COAX adapters are equipped with BNC connections. COAX cables applied by the user must convert from/to BNC and F (CATV) or other plug types.

1. Open "Cable Type" on start screen.
2. Use **Arrow Keys** to navigate to option *Ethernet* and confirm with **Enter**.
3. Use **Arrow Keys** to navigate to desired cable type and confirm with **Enter**.
4. Connect Coax adapters to Display handset (DH) and Remote handset (RH).
5. Connect the short coaxial calibration cable to the adapters of Display handset (DH) and Remote handset (RH).
6. Use **Arrow Keys** to navigate on ready screen to "Calibration" and press **Enter**.

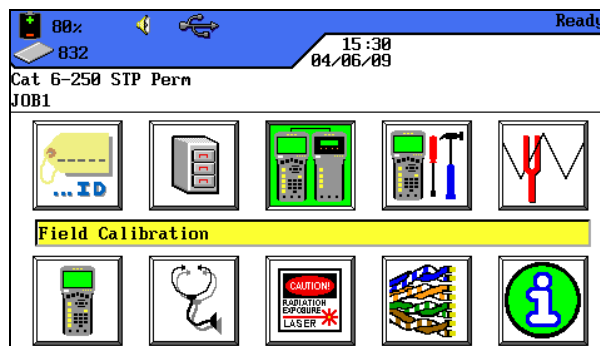

Illustration 1 5.9.2. Ready Screen

7. Use soft key **Start** to initiate calibration.

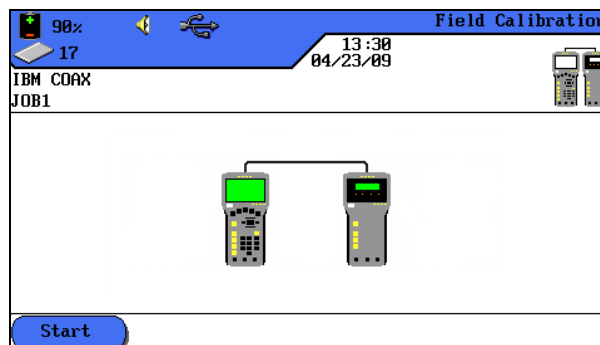

Illustration 2 5.9.2. Coaxial Cable Calibration

8. After completion of calibration and display of according message, press **Escape** to return to main screen.

5.10. Perform Autotest

Autotest is performed after all preferences have been carried out.

1. Disconnect the cable line to be tested from all network components.
2. Using suitable patch cords, connect the Display handset (DH) to one end of the cable line (link), and the Remote handset (RH) to the opposite end of the cable line (link).
3. Start by pressing **Autotest**.

5.11. Open Job Folder of Autotest

The internal memory of LanTEK®II Cable Tester can hold a maximum of 1700 individual TIA CAT-6 Autotest results with graphs, which can later be loaded again via *File* . The Autotest results can be saved immediately after the test.

- The complete set of test results is saved in a file.
- The test results are automatically saved if Autosave option is enabled.
- Completed tests are automatically assigned a name. If another name is desired, the test can be renamed via option *Rename*.

5.11.1. Job Options

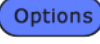
1. Open "File" on start screen.
2. Use **Arrow Keys** to navigate to the desired job folder. The display is highlighted yellow.
3. Use soft key  to open job options.

Job Options	Description
Current Job Info	The display shows the total number of passed/failed tests, cable length and memory used for the highlighted job folder.
All Job Info	The display shows the total number of passed/failed tests, cable length and memory used for all highlighted job folders.
Permanently Delete Selected Jobs	The selected job folder is deleted.
Rename Job	Renaming highlighted job folder.
New Job	Adding a new job folder to job list.
Make Job Current	Enables highlighted job folder. Autotests are now stored under this job.

5.11.2. Test Options

1. Use **Arrow Keys** to navigate to the desired job folder. The display is highlighted yellow.
2. Press **Enter** to display single tests.

3. Use soft key **Options** to open Test Options.

Test Options	Description
Select all	Selects all stored test results.
Select All Passed	Selects only passed tests for editing.
Select All Failed	Selects only failed tests for editing.
Deselect All	Deselects all stored test results.
Permanently Delete Selected Tests	Deletes highlighted test results.
Permanently Delete All	Deletes all stored test results.

Test Options	Description
Results Info	Displays information on test results, such as number of tests, number of passed/failed tests. Tested lengths and memory used.
Selected Results Info	Displays results of selected tests.
Rename Test	Renames selected test results.

5.11.3. Copy Job Folder to USB Removable Storage

1. Insert the USB removable storage into the USB port of Display handset (DH).
2. Navigate in job list with **Arrow Keys** to job folder to be copied, and highlight it with soft key **Select** (it is possible to highlight several job folders).
3. Use soft key **Options** to open job options.
4. Navigate with **Arrow Keys** to *Copy Selected Jobs to USB Flash Drive* and press **Enter**.

5.11.4. Alien Crosstalk Measurements (AXT)

Use soft key **AXT** in display of job list to open the saved Alien Crosstalk Measurements and to copy them to a USB removable storage.

5.12. Autotest Results and Graphs

The Autotest results can be displayed as table or graph.

1. Open "File" on start screen.
2. Use **Arrow Keys** to navigate to the desired job folder. The display is highlighted yellow.
3. Use **Arrow Keys** to navigate to desired single test. The display is highlighted yellow.
4. Press **Enter** to display overview of single tests.

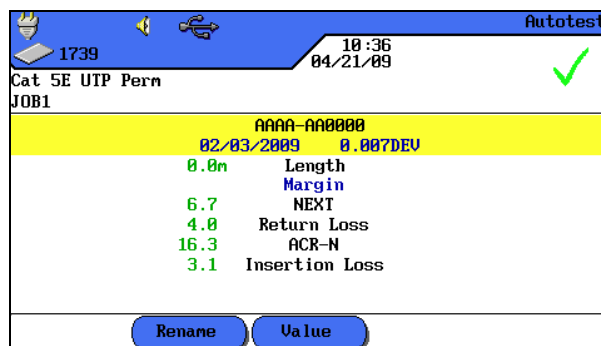

Illustration 1 5.12. Single test overview

- Press **Enter** again to open test series of single test.

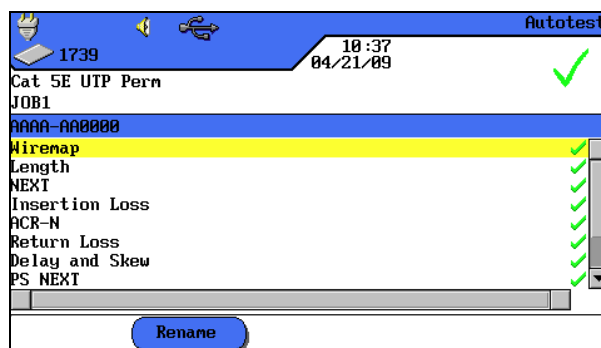

Illustration 2 5.12. Test series

- Use **Arrow Keys** to navigate to desired test series and press **Enter** to display result table.

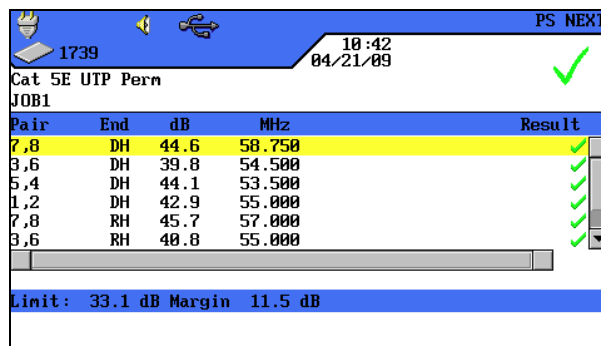

Illustration 3 5.12. Result Table

- Use **Arrow Keys** to navigate to desired test result and press **Enter** to display graph.

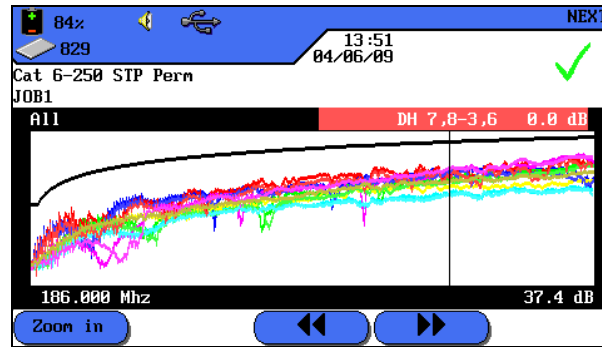

Illustration 4 5.12. NEXT Graph

When opening graph, cursor is always in worst case margin. In this example, cursor is positioned on horizontal axis at 186 MHz.

- Press **Escape** to return to previous screen.

5.12.1. Graph Formats, Layouts and Controls

Graphs make it easier to recognize the relation between two network parameters, the actually measured values and the pre-programmed limits.

The horizontal axis indicates the frequency values and the vertical axis the measured values in dB. The limits are drawn as solid line.

Table view

Pair	End	dB	MHz	Result
7,8-3,6	DH	71.2	6.550	
7,8-5,4	DH	23.3	243.500	
7,8-1,2	DH	87.0	2.800	
3,6-5,4	DH	63.5	13.150	
3,6-1,2	DH	18.3	245.000	
5,4-1,2	DH	39.2	142.000	
Limit: 56.2 dB Margin 15.0 dB				

Graph view

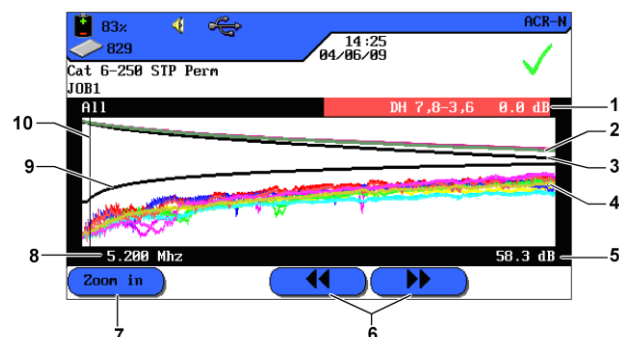



Illustration 5.12.1. Table View and Graph View

The margins indicated at lower right in table view provide information on worst case distance between the actual measuring values and the specified limits, as shown by the cursor position in the graph on the right.

	Description
1	Wire pair, plotted on the basis of the table data.
2	Specified limit curve for worst case loss value.

3	The actual measurement curve of the wire pair. In this case, the loss is displayed.
4	The actual measurement curve of the wire pair.
5	Vertical axis with measuring values in dB.
6	Use arrow keys to move cursor horizontally. When cursor position is changed, the measuring values displayed on screen are changed as well. Use soft keys  and  to move cursor in larger steps. Use Arrow Keys to move cursor in smaller steps. While SHIFT key is pressed, cursor can be moved in large steps with Arrow Keys .
7	Enlargement or reduction of view of horizontal axis. At maximum size, these keys have no function.
8	Horizontal axis with frequency values.
9	Specified limit curve for worst case NEXT value.
10	During initial display of wire pair graph, the cursor is automatically at worst case limit and frequency location.

6.1. Test Setup for Single Test Analysis

- Perform calibration if LanTEK®II Cable Tester has not been calibrated during the last 7 days.
- Select cable type.
- Separate cable line to be tested from all network components.
- Connect adapter and patch cord to Display handset (DH) and Remote handset (RH).
- Connect patch cord of display handset (DH) to one end of the cable line and the patch cord of remote handset (RH) to the other end.

6.2. Test Run of Single Test Analysis

When performing an analysis test, the following sequences are initiated:

- If test requires Remote handset (RH), the Display handset (DH) initially attempts to establish a connection to the Remote handset (RH). If connection cannot be established, the Display handset (DH) will show the message "Searching for Remote (RH)". The search is continued until the analysis test is manually cancelled or the Remote handset (RH) is located.
- After connection to the Remote handset (RH) has been successfully established, its serial number is read out to check if current configuration data are available. If during the last 7 days no calibration has been performed on the identified Remote handset (RH), the user receives a message that calibration is recommended.
- Display handset (DH) continues the selected single test if serial number is valid.
- If test does not require a Remote handset (RH), the Display handset (DH) performs the test and displays the result.

NOTE:

When pressing Escape, the Display handset (DH) stops Searching for Remote (RH) and initiates the test under conditions that do not require a Remote handset (RH).

- Once test is completed, the results can be displayed or printed.

6.3. Perform Single Test Analysis

1. Connect Display (DH) and Remote (RH) handset to cable line that is to be tested.
2. Open "Analyze" on start screen.
3. The tests available for the selected cable type are displayed.
4. Use **Arrow Keys** to navigate to desired test.

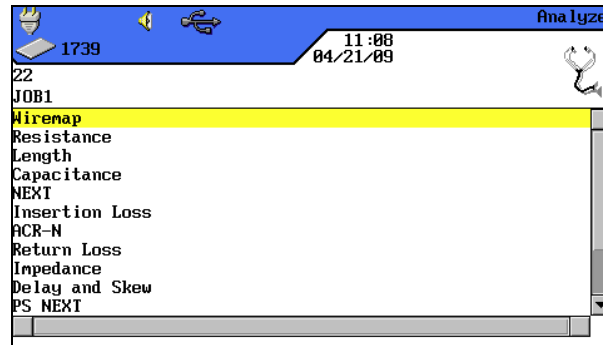
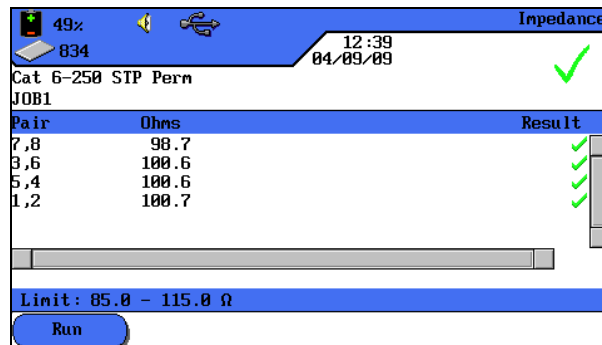

Illustration 6.3. Single Tests

5. Confirm selection of test with **Enter**. After completion of test, a result table opens.

6.4. Evaluation of Analysis Test Results

The overall result of the analysis test is displayed in the upper right on the screen below the title bar. The results for the individual wire pairs are displayed on the right side of the respective test.



Overall Result

Individual Results

Illustration 6.4. Evaluation of Analysis Test Results

The above example shows the screen for DC resistance.

- The overall result of the test appears in the upper right, beside the date.
- The results of the individual wire pairs appear in the last column on the right (result column).

The results for the overall test and the single tests are indicated similar to Autotest.

6.4.1. Graphs for Analysis Tests

After completion of test series, certain analysis results can be displayed in table or graph format. The graph display in analysis mode is comparable to the one of Autotest.

6.5. Overview of Single Test Analysis

Analysis mode allows fault repair by performing single tests, making changes and displaying changed test results. With the analysis test it is possible to check the cable continuously for damage or overstretching.

Depending on cable type and specified test standard, the following single test analyses are available:

Wiremap	Resistance	Length
Capacitance	NEXT	Loss/Insertion Loss
ACR-N (ACR)	Return loss	Impedance
Delay and Skew	Power Sum NEXT	Power Sum ACR-N (Power Sum ACR)
Margin	ACR-F (ELFEXT)	Power Sum ACR-F (Power Sum ELFEXT)

NOTE:

The following tests do not require a Remote handset (RH): Resistance, Length, Capacitance, Impedance, Delay and Skew.

6.6. Wiremap Test

With the aid of Wiremap tests it is possible to pinpoint short circuits, interrupts and incorrect wiring. To facilitate evaluation, the test results are displayed in graph format.

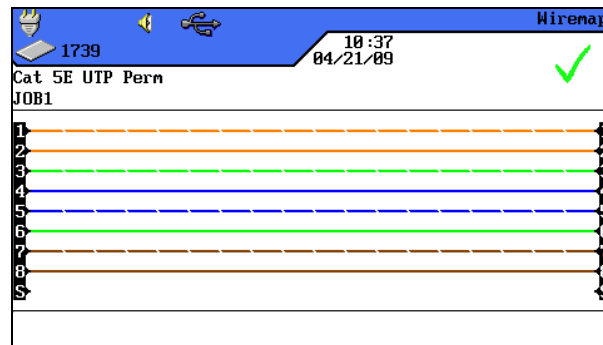

Illustration 6.6. Wiremap Test

An error indicated by the Wiremap test should always be corrected first, since it will cause errors in other tests. An unwired contact can cause the tests for DC loop resistance and loss to receive a failing grade as well. An interrupt can also lead to a zero result when testing capacitance, resulting in failed NEXT measuring values.

The Wiremap test ensures the following minimum thresholds for fault recognition (based on four wire pairs, optional shield):

- All Wiremap errors or combined Wiremap errors are indicated as errors in the Wiremap diagram.
- All combinations of up to three interrupts, short circuits or reversed connections are correctly detected.
- In case of interrupts and short circuits, the cable end at which the error occurred is indicated (on Autotest screen for length measurement).
- Split wire pairs (Split Pairs) are detected by specific patterns of contradictory NEXT values (Near End Cross-Talk).

6.7. Length Test

This test determines the length of wire pairs to ensure that the recommended limits for the selected cable are complied with. Depending on the measurement unit selected in "Preferences", the length is indicated in Foot or Meter.

Pair	NVP	n	Result
7,8	0.72	0.0	✓
3,6	0.72	0.0	✓
5,4	0.72	0.0	✓
1,2	0.72	0.0	✓

Limit: 0.0 n - 90.0 n

Illustration 6.7. Length Test

6.7.1. Length Test Error

Minor length differences can occur between the wire pairs of a cable due to small NVP differences, as well as length differences caused by transposition. A failure exists if the electronically measured cable length deviates too much from the actual length.

6.8. Resistance Test

This test determines the loop resistance of the individual wire pairs. This ensures that the total loop resistance does not exceed the recommended limits. For each wire pair, the results are displayed as resistance value in ohm, together with the reference limit for the cable type.

Pair	Ohms	Result
7,8	98.7	✓
3,6	100.6	✓
5,4	100.6	✓
1,2	100.7	✓

Limit: 85.0 - 115.0 Ω

Run

Illustration 6.8. Resistance Test

6.8.1. Resistance Test Error

All four wire pairs of a transmission line within the network should have approximately the same resistance. If the resistance value of a wire pair exceeds the limit, the test is considered failed.

6.9. NEXT, ACR-F (ELFEXT) and Power Sum

In an Autotest, crosstalk at the near and far end of the cable is measured with NEXT (Near End Cross Talk) and ACR-F (ELFEXT) tests. High crosstalk levels can result in frequent recurrences, damage to data and other interferences that impair transmission rate.

NEXT					ACR-F				
1739 10:38 04/21/09 ✓					1739 10:48 04/21/09 ✓				
Cat 5E UTP Perm JOB1					Cat 5E UTP Perm JOB1				
Pair	End	dB	MHz	Result	Pair	End	dB	MHz	Result
7,8-3,6	DH	45.2	58.750	✓	7,8-3,6	DH	82.7	1.000	✓
7,8-5,4	DH	55.1	55.000	✓	7,8-5,4	DH	89.5	1.000	✓
7,8-1,2	DH	60.2	50.250	✓	7,8-1,2	DH	85.4	1.000	✓
3,6-5,4	DH	44.9	53.500	✓	3,6-7,8	DH	83.0	1.000	✓
3,6-1,2	DH	43.0	57.250	✓	3,6-5,4	DH	43.7	83.500	✓
5,4-1,2	DH	54.4	50.250	✓	3,6-1,2	DH	75.9	1.000	✓
Limit: 36.1 dB Margin 9.1 dB					Limit: 58.6 dB Margin 24.1 dB				

Illustration 6.9. NEXT, ACR-F (ELFEXT) and Power Sum

The NEXT test determines interfering effects (crosstalk) of a transmitting wire pair on the adjacent wire pair in the same cable. NEXT is measured on Display handset (DH) and Remote handset (RH).

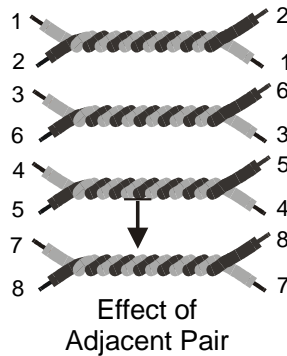

- FEXT test and NEXT measurement are similar; the only difference is that in FEXT test the transmissions emanate from Remote handset (RH) and that crosstalk is determined at Display handset (DH).
- NEXT measurements are performed on each cable end and for all wire pair combinations (pair 1-2 to 3-6 etc.). Thus, a total of 12 measurements is performed.
- ACR-F (ELFEXT) measurements take place with the Display handset (DH) and the Remote handset (RH) on both cable ends and for all possible wire pair combinations (1-2 to 3-6, 3-6 to 1-2, 1-2 etc.). This results in a total of 12 measurements.

6.10. Power Sum NEXT, Power Sum ACR-F (ELFEXT)

Power Sum-Tests determine the crosstalk effects of three transmitting wire pairs on the fourth wire pair in the same cable.

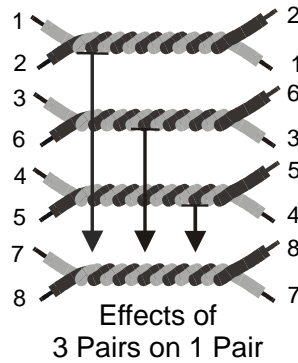

When using Power Sum NEXT, four (4) calculations on each cable end and on each wire pair combination (pairs 1-2, 3-6 and 4-5 to 7-8 etc.) are performed. A total of eight (8) values is obtained.

Pair	End	dB	MHz	Result
7,8	DH	44.6	58.750	✓
3,6	DH	39.8	54.500	✓
5,4	DH	44.1	53.500	✓
1,2	DH	42.9	55.000	✓
7,8	RH	45.7	57.000	✓
3,6	RH	40.8	55.000	✓

Limit: 33.1 dB Margin 11.5 dB

Illustration 1 6.10.1. Power Sum NEXT

NOTE:

The Power Sum NEXT values are usually 2 - 3 dB below the value (= stronger crosstalk) than with conventional NEXT measurement.

When using Power Sum ACR-F (Power Sum ELFEXT), four (4) calculations on the side of the Display handset (DH) and on each wire pair combination (pairs 1-2, 3-6 and 4-5 to 7-8 etc.) are performed. A total of eight (8) values is obtained.

Pair	End	dB	MHz	Result
7,8	DH	80.2	1.000	✓
3,6	DH	74.5	1.000	✓
5,4	DH	81.0	1.000	✓
1,2	DH	75.1	1.000	✓
7,8	RH	80.7	1.000	✓
3,6	RH	74.1	1.000	✓

Limit: 55.6 dB Margin 24.6 dB

Illustration 2 6.10.1. Power Sum ACR-F (Power Sum ELFEXT)

6.10.1. NEXT Test and ACR-F (Power Sum ELFEXT) Test Error

Crosstalk is usually caused by faulty connections at the cable ends. The lower the measuring values in dB, the stronger the crosstalk.

6.11. Insertion Loss Test (Attenuation)

This test determines the overall insertion loss of the signal in the cable and checks compliance with limits. A minor loss is the prerequisite for a faultless transmission. Insertion loss measurement is performed by feeding a signal with known amplitude into the Remote handset (RH) and then reading the amplitude on the Display handset (DH).

Pair	End	dB	MHz	Result
7,8	DH	1.4	3.100	✓
3,6	DH	1.4	3.100	✓
5,4	DH	1.4	3.100	✓
1,2	DH	1.4	3.100	✓

Limit: 3.1 dB Margin 1.7 dB

Run

Illustration 6.11. Loss Test

6.11.1. Insertion Loss test Error

The insertion loss reduces the signal in the cable. Loss increases with cable length, signal frequency and temperature. With the aid of loss tests it is possible to detect faults in cable, connections and connection technology. A high loss value in dB indicates a strong loss, and thus a higher signal reduction.

6.12. Return Loss Test

This test determines the relation between reflected and transmitted signal amplitude. High-grade cable lines exhibit only minor reflection, thus demonstrating a good impedance adjustment of the individual components connected to the cable.

Pair	End	dB	MHz	Result
7,8	DH	21.8	92.250	✓
3,6	DH	17.8	100.000	✓
5,4	DH	16.4	91.250	✓
1,2	DH	18.8	65.000	✓
7,8	RH	21.6	100.000	✓
3,6	RH	22.6	68.500	✓

Limit: 12.4 dB Margin 9.4 dB

Illustration 6.12. Return Loss Test

6.12.1. Return Loss Test Error

Same as with loss, an excessive return loss also results in signal reduction at the reception end. It also indicates that an impedance mismatch exists in a section of the cable. A value of 20 dB or higher indicates a good twisted-pair cable.

6.13. Impedance Test

The average impedance is calculated from delay of electrical signal and capacitance measurement. The result is indicated in ohm. The average impedance can help in indentifying damages to cable, connections or cable sections with impedance mismatch.

Since this test uses a capacity measurement, the correct cable type must be indicated to obtain a precise measuring result.

NOTE:

The measurements are incorrectly calculated if the setting is for a type CAT 3 cable (the cable insulation containing PVC), but the test is actually performed on a CAT 5 cable (insulation containing Teflon®). Therefore, ensure that the correct cable type is selected.

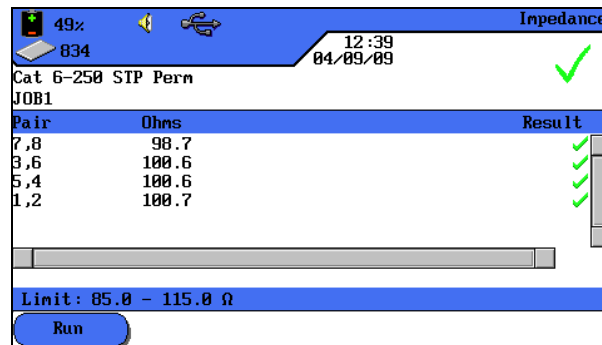

Illustration 6.13. Impedance Test

6.13.1. Impedance Error

Impedance errors cause signal reflections and signal reduction. Average impedance of wire pairs should comply with LAN system impedance of 100, 120 or 150 Ω.

6.14. Delay and Skew Test

This test determines the delay of a test signal that was fed at one end of the cable to the other end of the cable. The delay skew indicates the difference between the measured delay of the corresponding wire pair and the wire pair with the lowest delay value. The limits specified for delay and skew depend on selected cable type.

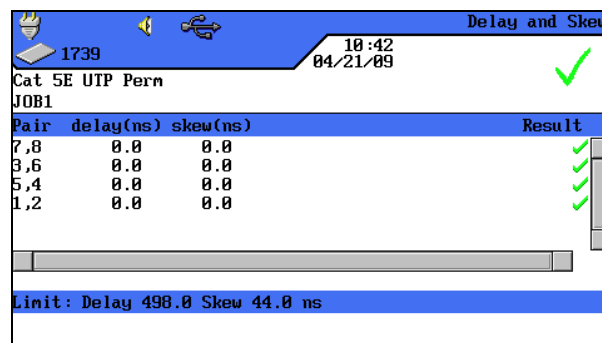

Illustration 6.14. Delay and Skew Test

6.14.1. Delay and Skew Test Error

The delay and skew measurements usually result in slightly different values for the individual wire pairs of a cable. However, a large difference indicates a cable fault or a damaged wire pair.

6.15. Capacitance Test

This test determines the mutual capacitance between the two conductors of each wire pair, to ensure that the capacitance of the corresponding cable type has not been impaired by the installation.

- The capacitance test of the analysis mode indicates the overall capacitance in Nanofarad (nF).
- The Autotest measures the overall capacitance in Picofarad (pF) per meter or foot.

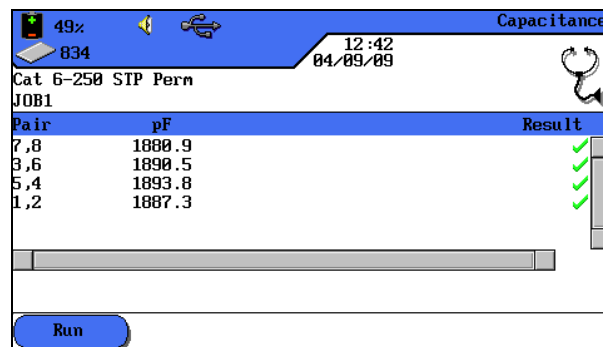

The screenshot shows a software window titled "Capacitance" with a magnification of 49%. The window displays test parameters: "834", "12:42", "04/09/09", "Cat 6-250 STP Perm", and "JOB1". Below this is a table with three columns: "Pair", "pF", and "Result". The table contains four rows of data, each with a green checkmark in the "Result" column. At the bottom of the window is a "Run" button.

Pair	pF	Result
7,8	1888.9	✓
3,6	1890.5	✓
5,4	1893.8	✓
1,2	1887.3	✓

Illustration 6.15. Capacitance Test

6.15.1. Capacitance Test Error

The higher the capacitance, the higher the error rate. Due to transport and installation of the cable, minor changes in capacitance are normal. Connectors and patch cords also influence capacitance values.

6.16. ACR-N (ACR) Test and Power Sum ACR-N (Power Sum ACR) Test

The ACR-N (ACR) test determines the loss-crosstalk distance by means of a mathematical comparison (difference calculation) of the loss and NEXT test results. The differences between the measuring values of a wire pair indicate whether transmission interferences are likely to occur in the respective wire pair.

The ACR-N (ACR) measurement is calculated from pair to pair. Power Sum ACR-N (Power Sum ACR) measurement is calculated by summation of NEXT values between a selected wire pair and three other wire pairs of the same cable.

Pair	End	dB	MHz	Result
7,8-3,6	DH	78.4	2.800	✓
7,8-5,4	DH	88.6	4.300	✓
7,8-1,2	DH	88.9	1.000	✓
3,6-5,4	DH	78.5	1.000	✓
3,6-1,2	DH	73.4	2.950	✓
5,4-1,2	DH	76.6	4.750	✓

Pair	End	dB	MHz	Result
7,8	DH	78.2	2.800	✓
3,6	DH	67.9	2.800	✓
5,4	DH	77.6	1.000	✓
1,2	DH	72.6	2.950	✓
7,8	RH	71.8	2.500	✓
3,6	RH	67.5	2.950	✓

Illustration 6.16. ACR-N (ACR) / Power Sum ACR-N (Power Sum ACR)

6.16.1. ACR-N (ACR) Test and Power Sum ACR-N (Power Sum ACR) Test Error

A large difference between the measuring values is preferable, since this indicates a strong signal and minor perturbations.

6.16.2. Troubleshooting ACR-N (ACR) Test and Power Sum ACR-N (Power Sum ACR) Test Error

For information on troubleshooting, refer to the corresponding sections on NEXT and loss test.

6.17. Headroom Test

The headroom test is a mathematical analysis of the data calculated during the preceding test. The sum of Power Sum ACR-N (Power Sum ACR) test (i.e. corresponding value of worst case wire pair after normalization of wire pair loss over 100 meters) and the additional margin between the worst case Power Sum NEXT-value and the limit for Power Sum NEXT.

The headroom test is a simple way to indicate the margins available on a cable line for faultless support of an application. This test also indicates the additional margin obtainable by using "improved" cables and connections, as well as careful installation.

dB	Result
51.9	✓

Illustration 6.17. Margin Test

6.17.1. Headroom Test Error

The headroom value indicated in dB identifies the minimum margin available for a cable line. A high value is preferable, since it indicates a strong signal and minor perturbations. The pass/fail limits for the margin are identical with those for Power Sum ACR-N (ACR).

6.18. Custom Cable Preferences and Cable Parameters

All cable types pre-programmed in LanTEK®II Cable Tester are based on a predefined test standard. These pre-programmed preferences cannot be changed. If you wish to perform other tests on a selected cable line, you first must create a custom cable.

Example: In addition to TIA 568B Category 5 tests, the return loss is to be measured (which is not required by TIA). For this purpose, a custom cable is created and the tests selected that are to be included in the test series for this cable.

A maximum of ten (10) custom cables can be created, stored, deleted and, if required, loaded.

6.18.1. Creating a New Customs Cable Type

1. Open "Cable Type" on start screen.
2. Use **Arrow Keys** to navigate to desired cable type.

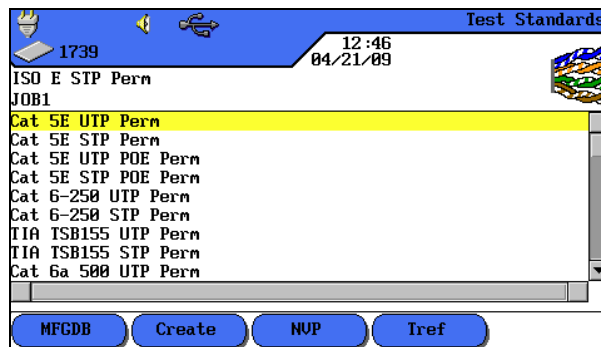

Illustration 1 6.18.1. Cable Type

3. Use the soft key **Create** to open menu selection.

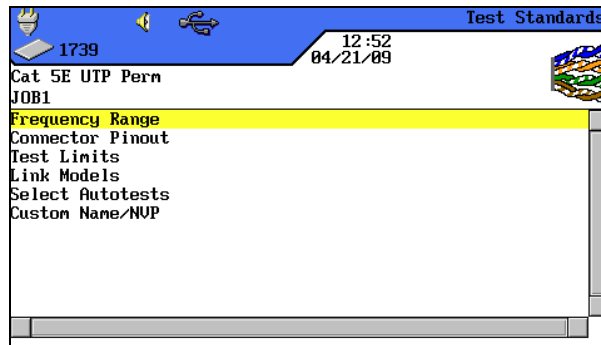

Illustration 2 6.18.1. Menu Selection Test Standards

4. Use **Arrow Keys** to navigate to *Custom Name/NVP* and confirm with **Enter**.

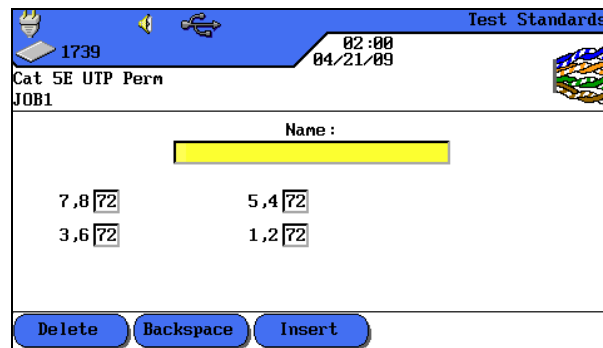



Illustration 3 6.18.1. Custom Name/NVP

5. Assign a name for the newly created custom cable The soft key  appears.
6. Use **alphanumeric** keys to enter one or several NVP values, if required.
7. Use soft key  to accept changes and return to screen to create a custom cable.

6.18.2. Select Custom Cable Type

The custom cable type can be edited at any time or selected as current cable type.

1. Open "Cable Type" on start screen.
2. Use **Arrow Keys** to navigate to *Custom Cable* and confirm with **Enter**.
3. Use **Arrow Keys** to navigate to desired custom cable type and confirm with **Enter**.

6.18.3. Custom Cable Parameters

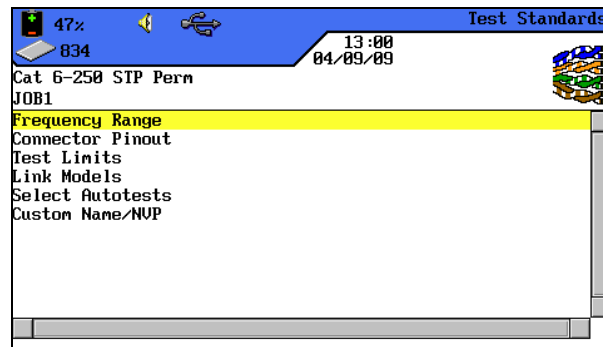

Illustration 6.18.3. Custom Cable Parameters

Parameters	Description
Frequency range	Use this menu to set the lowest and highest frequency for certification and evaluation of cable performance.
Connector Pinout	Use this screen to determine the configuration of the contact pins of the plug. Note: Tests for NEXT, loss, capacitance, DC-resistance and impedance cannot be performed on wire pairs that have not been selected.
Test Limits	Use this screen to adjust the pass/fail limits for the Autotest to your requirements.
Link models	The custom limits for NEXT and loss are specified as constant limit or according to the link models. The frequency limits depend on LanTEK® II

	model and link type.
Select Autotests	Not all cable lines require the complete Autotest test series. Use this option to select the individual Autotests to be performed.
Custom Name/NVP	Use alphanumeric keys to enter a custom name or edit the NVP value. LanTEK®II Cable Tester can save up to 10 custom cable types.

7.1. PROPERTIES OF COAXIAL CABLES

The coaxial cable offers numerous benefits. It is hardly influenced by electromagnetic disturbances and supports high bandwidths. Thus, many customers prefer using the coaxial cable for their cable TV and data applications.

A typical coaxial cable consists of:

- **Center Conductor:** This conductor usually consists of a fairly heavy, solid and yet flexible wire. Stranded wire is also used. Though solid conductors are preferred for permanent installation, a cable with stranded wires is more flexible and easier to connect to devices.
- **Insulation:** Also referred to as dielectric layer. It ensures electrical insulation and keeps the inner and outer conductors in precise coaxial alignment.
- **Outer Conductor or Shield:** This layer protects the inner conductor from external electrical perturbations. The shield can consist of wire mesh, metal foil or a combination of both. This shield makes the coaxial cable extremely impervious to electromagnetic disturbances.
- **Sheath:** A robust sheath made of plastic or Teflon protects the coaxial cable from mechanical damage.

Coaxial cables differ by their impedance (in ohm), which indicates the cable's resistance of the current. Thus, a coaxial cable of type RG-59 and RG-6 typically has an impedance of 75 ohm, whereas a RG-58 cable has 50 ohm.

7.2. Troubleshooting Coaxial Cables

Use only high-grade connectors and tools to properly seal coaxial cable networks. If cable has an error, check the following failure points:

- **Faulty connection:** Check if neutral conductor is properly separated from shield.
- **Cable Short Circuit:** Could occur if cable has been improperly connected to near and far end. In case of a short circuit, check the resistance values indicated on the tester. A value of 0 (zero) indicates that the fault is located at the near end of the cable, whereas a value of ~ 20 ohm points to the far end.
- **Cable Interruption:** Occurs frequently. In this case, check out the length measurement result. A value of 0 (zero) for cable length points to a fault located at the near end.

8.1. Safety Precautions



WARNING!

NEVER look directly into the port of measuring adapter, at connector surface, open fiber ends or into couplers. There is a risk of light emerging from the fiber that is not visible, which could permanently damage your eyes.

If you are not sure whether the device is switched on or whether the fiber transmits light, for safety reasons always assume that the device is active.

Handle bare fibers properly; there is a risk of injury from fiber splinters.

Protect your eyes when working with bare fibers; fiber splinters could permanently damage your eyes.

Never let fiber scraps lie openly and never dispose of them loosely in normal waste containers; there is a risk of injury from fiber splinters.



CAUTION!

When connecting the measuring adapter to a light-conducting line, the maximum measuring range must be observed (see specifications of individual modules). Exceeding it could result in damages to FiberTEK™ FDX modules.

8.2. Notes on Cleaning Measuring Adapter and Patch Cord

NOTE:

Before connecting cable adapter to FiberTEK™ FDX adapter, ensure that the plugs of cable connectors are clean.

Clean ferrules of measuring adapter only with dry, lint-free, non-abrasive materials. The plugs can be cleaned with suitable fiber cleaning cloths or cleaning pens. IDEAL recommends cleaning set #1219-00-1621 to care for the modules and patch cord.

8.3. Performance Specification

Technical Information	FiberTEK™ FDX	
Detector Wavelength (reception):	MM: 850 nm, 1300 nm SM: 1310 nm, 1550 nm	
Laser type (transmitter) MM 850 nm: MM 1300 nm: SM 1310 nm: SM 1550 nm:	VCSEL and LED Fabry-Perot MCW (GRIN lens, focused) Fabry-Perot MCW (GRIN lens, focused) Fabry-Perot MCW (GRIN lens, focused)	
Accuracy level Loss: Length:	MM 850/1300 nm: SM 1310/1550 nm: (+/-3%) + 1 meter	0.25 dB 0.25 dB
Display resolution: Loss: Length:	MM 850/1300 nm: SM 1310/1550 nm: MM 850/1300 nm: SM 1310/1550 nm:	0.1 dB 0.1 dB 0.1 meter 0.1 meter
Linearity	0.2 dB	
Length ranges	MM 850 nm: MM 1300 nm: SM 1310 nm: SM 1550 nm:	3,000 meter 3,000 meter 10,000 meter 10,000 meter

8.4. Test Setup According to Reference Method with Three Test Cords (based on ISO/IEC 14763-3)

This is the preferred measuring method, which can be used for any topology - both installation and transmission line. Irrespective of the plug face, it is also used on the measuring equipment and within the transmission line.

Calibration takes place via reference line between the launch cords and tail cords used for measurement.

This measurement method is applied to FiberTEK™ FDX.

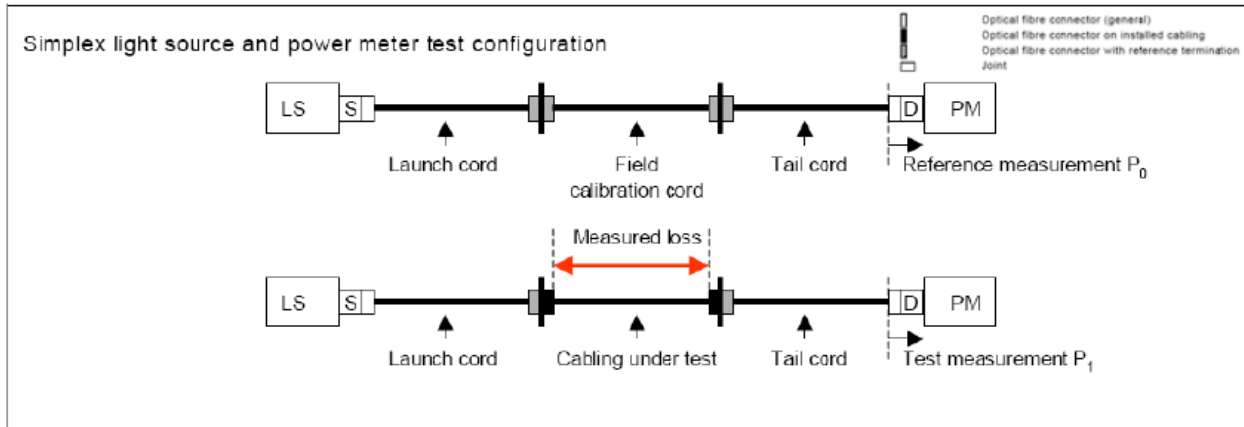

Illustration 8.4. Test Setup According to Reference Method with Three Test Cords

8.5. Test setup According to Reference Method with One Test Cord (based on ISO/IEC 14763-3)

This measuring method is only permitted for measurement of installation lines that are set up as Simplex lines. Furthermore, all connectors on the measuring equipment and within the line must be of the same type.

Calibration is performed with the launch cord used for the measurement. Subsequently, the line to be measured and a tail cord are introduced.

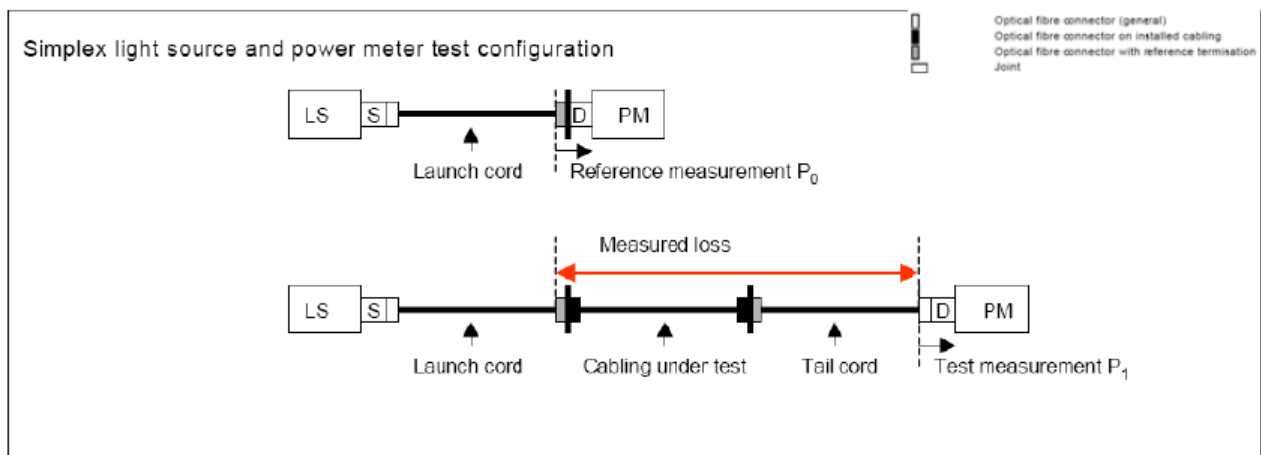

Illustration 8.5. Test Setup According to Reference Method with One Test Cord

8.6. Set Autotest Pref

Autotest is the test mode used most often. The Autotest allows various presettings:

- Automatic saving
- Passed/Failed Rating
 1. On start screen of Display handset (DH) select option *Preferences*.
 2. Select option *Autotest Pref*.
 3. Now enter the desired preferences in the opening screen.

NOTE:

Please note that Autotest Pref entered by you must be in compliance with the requirements of the certification to be carried out.

8.6.1. Selection of Module (fiber type)

1. Use **Arrow Keys** to navigate on ready screen to "Fiber" display and confirm with **Enter**.
2. Mark the wavelength in accordance with the fiber to be measured. If the loss budget has already been determined, accept the preset value with **Enter** and confirm with **Enter**.

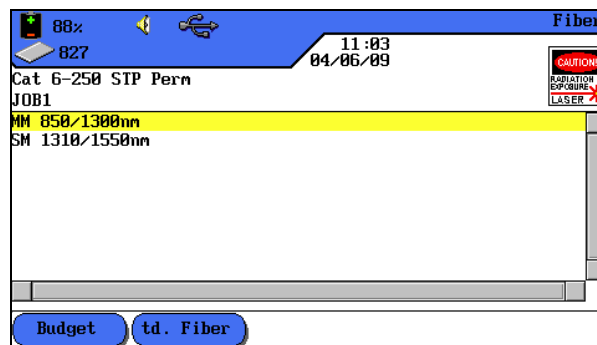

Illustration 8.6.1. Select Wavelength

8.6.2. Determine Loss Budget

The loss budget influences the passed/failed thresholds for the loss measurements performed with FiberTEK™ FDX. However, since the loss budget has no impact on the actual loss measurement, this function is for informative purposes only. If the measured loss is smaller or equal to the loss budget, a ✓ is displayed. If the loss exceeds the loss budget, the following symbol appears: ✗.

1. Use soft key **Budget** to open Loss Budget Menu and to change limits according to wavelength.
2. Use soft keys **850nm**, **1300nm**, **1310nm** and **1550nm** to select the according wavelength to specify the loss budget.

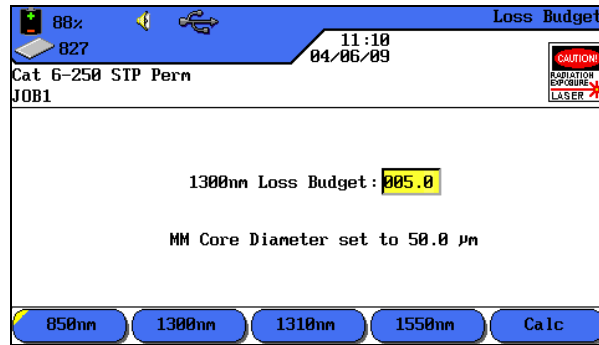

Illustration 1 8.6.2. Manual Specification of Loss Budget

NOTE:

Refer to chapter Specifications in this instruction manual to find an overview of cabling standards and application requirements for the installation of fibers.

The current limit for the loss is displayed in box *Limit*.

3. If you want to keep the value, confirm with **Enter**, or use keypad to enter a number or use the **Calc** soft key to open input box for loss budget calculator.
4. Use **Up/Down Arrow Keys** to navigate to individual boxes and use **alphanumeric** keys to enter details concerning the fiber line.

Length (m)	>	Loss/km
Fusion splices: Number	>	Loss
Connector Pairs: Number	>	Loss
Mechanical splices: Number	>	Loss

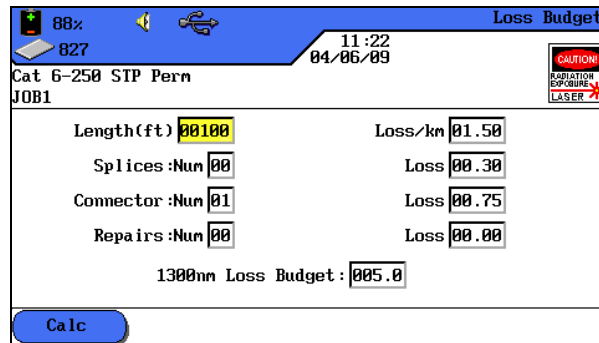

Illustration 2 8.6.2. Loss Budget Calculator

5. Use soft key **Calc** to calculate the budget. The result appears in *Loss Budget* box.
6. To confirm, press **Enter** in this box and press **Enter** in the next box.
7. Return to the Main Menu by pressing **Enter** once more.

Measurement with the new limits is performed and the result is displayed. For measurement purposes, continuous run can be started, the measurement saved or the limit changed once more.

8.7. Calibration

During calibration, FiberTEK™ FDX calculates a reference level for the loss measurement. Calibration accuracy depends on warm-up period of measuring adapter and quality of the test cords.



Illustration 8.7. Calibration (general)

NOTE:

The launch and tail cords must correspond to the type of fiber to be tested (e.g. 50- μm launch fibers for testing of 50- μm cable).

All connections on launch, tail and reference cords must be in compliance with the requirements of ISO/IEC 14763-3 concerning length as well as insertion loss.

To ensure the specified measuring accuracy, a sufficient heating period must be considered for the measuring adapter.

The temperature of LanTEK®II Cable Tester and measuring adapter should correspond to the ambient temperature.

To prevent condensation on optics, do not remove dust covers on measuring adapters before performing cable test.

Close optical input/output again immediately with dust covers after removal of launch fibres.

The calibration values are saved in the Display handset (DH). The loss of the launch fibers and couplers used during calibration are deducted from the loss results during the cable test.

Before testing of fibers a calibration should be performed if:

- the launch cords have been subject to change or strong movement;
- the fiber type has been changed;
- the measuring adapters have been changed;
- a device has been powered on or off;
- the test setup has been moved;
- a connection from the port of FiberTEK™ FDX module has been removed/changed.

8.8. Performing Calibration

1. Connect Display handset (DH) and Remote handset (RH).

NOTE:

Delivery includes three (3) interchangeable connector adapters for ST, SC and FC connectors. Other possible plug faces (LC) must be handled with hybrid launch cords (Ex. SC-LC).

2. Use **Arrow Keys** to navigate on ready screen to "Calibration" and press **Enter**.



Illustration 1 8.8. Ready Screen

If calibration was not successful, implement the following measures:

- Check correct connection of launch cords.
- Check launch fiber connections for contamination. If necessary, clean connections and check with a fiber test microscope (IDEAL order number 45-332).
- Dirty launch fibers also contaminate the measuring adapter connections. Clean the connections on the FiberTEK™ FDX measuring adapters with an optical cleaning sponge.
- Check launch cords with a fiber continuity tester (IDEAL order number: VFF5) for continuity.
- Replace suspected damaged launch cords.

8.9. Evaluation of Autotest Results for Fibers (LWL)

8.9.1. Passed/Failed Rating

The overall Autotest result appears in the upper right of the Autotest screen. The single Autotest results appear on the right beside the corresponding tests.

Symbols for Overall Test Result

Symbol	Overall Autotest Result
✓	The overall Autotest was completed without errors if all single tests received a passing grade.
✗	The overall Autotest receives a failing grade if at least one single test failed.

Autotest Symbols for Single Tests



Symbol	Single Autotest Results
✓	Passed: All results are within the limits, with adequate margins.
✗	Failed: At least one result has exceeded the limit by more than the accuracy specified for the device.

8.9.2. Saving Current Autotest Results

The Autotest results can be saved in the internal memory of LanTEK® II Cable Tester immediately after the test.

- Only Autotests with the overall evaluation **Passed** can be automatically saved. Tests with failure rating must be manually saved.
- The test results are automatically saved if Autosave Pref is enabled.
- A name is automatically assigned to finished tests if Auto Increment function has been enabled. If another name is preferred, use option  to manually assign another name.

8.9.3. Manual Saving of Autotest Results (Autosave off)

1. To manually save an Autotest, at the bottom edge of the screen press the soft key .
2. Now a brief acknowledgement appears, indicating the name under which the test will be saved.
3. If the current name already exists a warning message appears, asking whether you want to overwrite the existing file or enter another name.
4. Press **Escape** to cancel and return to previous display without saving or  to overwrite existing file.

8.9.4. Working with Jobs

The Autotest is saved under a unique name. The test results can be viewed, printed or deleted on the *File* screen.

1. On the ready screen, select File option and open job list.
2. Mark the desired job. Use  to open the folder containing the option list.
3. Mark the desired function and confirm with Enter.

8.9.5. Display of Result Details

The Autotest is saved under an unmistakable name. The test results can be viewed, printed or deleted on the *File* screen.

1. On the ready screen, select *File* option and open Job List.
2. Mark the desired job. Press **Enter** to open the job.
3. Use **Arrow Keys** to mark the desired test record.
4. Press **Enter** to open the record.
5. Press **Escape** to return to previous screen at any time.

8.10. FiberTEK™ FDX Measuring Mode

The LanTEK®II Cable Tester selects the reference level and test limits based on the test selected. When testing fibers (LWL), the remote handset (RH) must be manually powered on.

1. Use **Arrow Keys** to navigate on ready screen to "Fiber" display and confirm with **Enter**.
2. Highlight the wavelength, according to fiber to be measured and confirm with **Enter**.

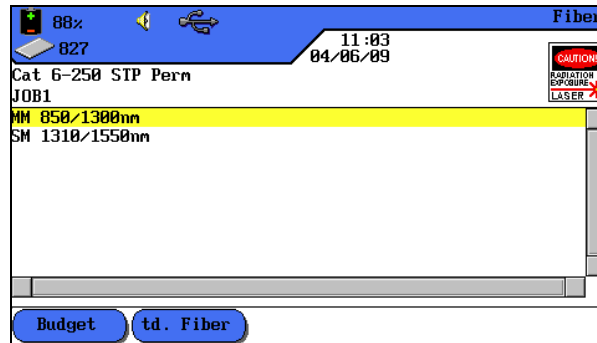

Illustration 1 8.10. Select Wavelength

3. Use **Arrow Keys** to navigate on ready screen to "Analyze" display and confirm with **Enter**.

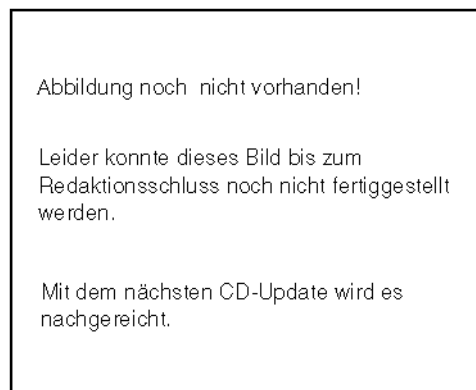

Illustration 8.10. Analyze

8.10.1. Continuous Run

This mode is used for troubleshooting. During continuous run, the measurement is repeated until it is manually cancelled. There is no save function.

1. Use **Arrow keys** to navigate to menu *Continuous Run* and press **Enter**.

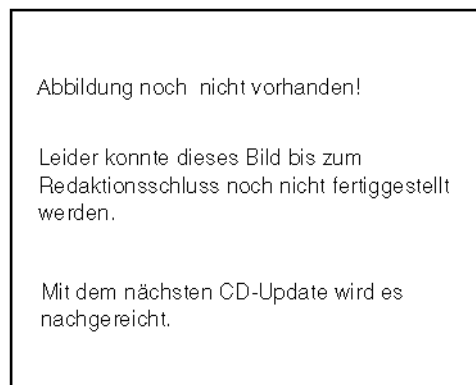

Illustration 8.10.1. Continuous Run

The measurement is performed and the result displayed.

2. Use soft key **Run** to start continuous run of measurement until it is finished by pressing soft key **Stop**.

3. Use soft key **Save As** to open menu to designate and save the test portion.
4. Use **Up/Down Arrow Keys** to navigate between the boxes, and use **Alphanumeric** keys to designate the test portion from/to.
5. Press **Enter** to save the entries. Use **Escape** to exit menu without making changes.

8.10.2. Power Meter Mode

Use the power meter (PM) mode to measure light power and loss, if according preferences are applied The test results can be saved and edited in IDEAL DataCENTER as "Power Meter".

1. Use **Arrow Keys** to navigate to menu *Power Meter Mode* and press **Enter**.

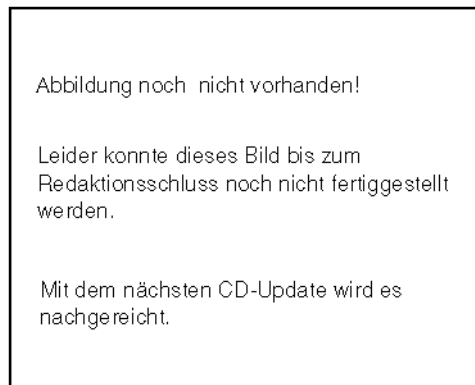

Illustration 8.10.2. Continuous Run

2. Use soft key **Run** to start continuous run of measurement until it is finished by pressing soft key **Stop**.
3. Use soft key **Save As** to open menu to designate and save the test portion.
4. Use **Up/Down Arrow Keys** to navigate between the boxes, and use **Alphanumeric** keys to designate the test portion from/to.
5. Press **Enter** to save the entries. Use **Escape** to exit menu without making changes.

8.10.3. Set Reference Value

Use soft key **Set Ref. Value** to define a value that can be used as reference for all subsequent measurements.

Use soft key **Toggle dBm** to switch the unit between *dBm (decibel-miliwatt)* and *mW (miliwatt)*.

Use soft key **Toggle Wavelength** to open the menu to select the wavelength.

8.10.4. Light Source Mode

The FiberTEK FDX can be used as a source for other meters or devices. Wavelength is adjustable and the source can be modulated for use with fiber identifiers.

8.11. Application-specific Configuration of a Fiber Test

The certification of fiber cabling is usually performed according to TIA-568 or ISO 11801 standards; in doing so, the passed/failed criterion is based on cable length, number of splices and connections in the fiber line.

In addition to these criteria, the LanTEK®II Cable Tester can also be configured for application-specific fiber tests. These fiber tests are particularly beneficial when determining whether a fiber line supports certain types of network technology, such as 100BaseSX or 1000BaseLX.

1. Use **Arrow Keys** to navigate on ready screen to "Fiber" display and press **Enter**.

8.11.1. Determine Loss Budget

2. Mark the wavelength according to fiber (LWL) to be measured and press soft key

Budget

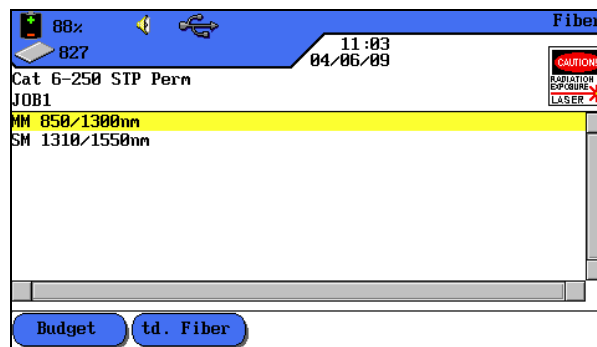

Illustration 1 8.11.1. Select Wavelength

3. Use soft keys **850nm**, **1300nm**, **1310nm** and **1550nm** to select the according wavelength to specify the loss budget.

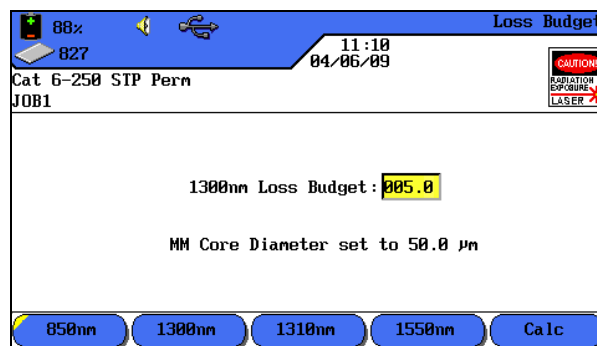

Illustration 2 8.11.1. Manual Specification of Loss Budget

NOTE:

Refer to chapter Specifications in this instruction manual to find an overview of cabling standards and application requirements for the installation of fibers.

The current limit for the loss is displayed in box *Limit*.

4. If you want to keep the value, confirm with **Enter**, or use soft key Calc to open input box for loss budget.
5. Use **Up/Down Arrow Keys** to navigate to individual boxes and use **alphanumeric** keys to enter details concerning the fiber line.

Length (m)	>	Loss/km
Fusion splices: Number	>	Loss
Connector Pairs: Number	>	Loss
Mechanical splices: Number	>	Loss

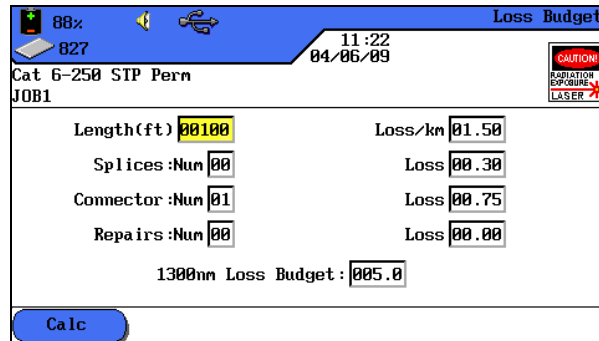

Illustration 3 8.11.1. Details concerning the fiber line

6. Use soft key **Calc** to start the calculation. The result appears in *Loss Budget* box.
7. To confirm, press **Enter** in this box and the next two boxes.

8.11.2. Select Fiber Standard and Determine Loss Budget

1. Mark the wavelength according to fiber to be measured and press soft key

Fiber Std

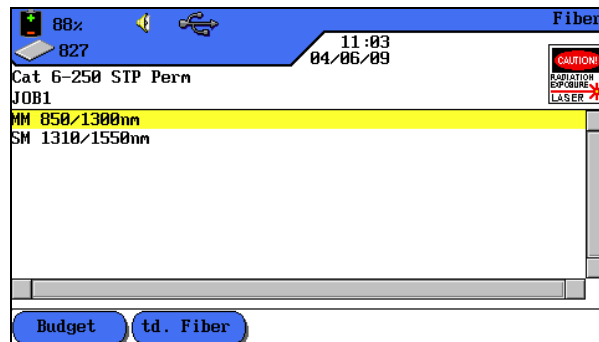

Illustration 1 8.11.2. Select Wavelength

2. Use **Arrow Keys** to navigate to desired cable type and confirm with **Enter**.

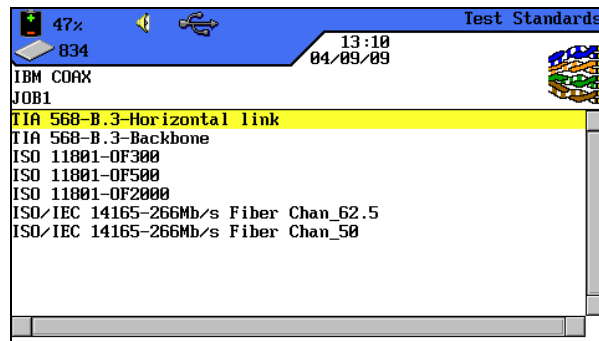

Illustration 2 8.11.2. Test Standard

3. Use soft key **50.0/62.5** to select core diameter.
4. Use soft key **850nm/1300nm** to select maximum insertion loss of according wavelength.

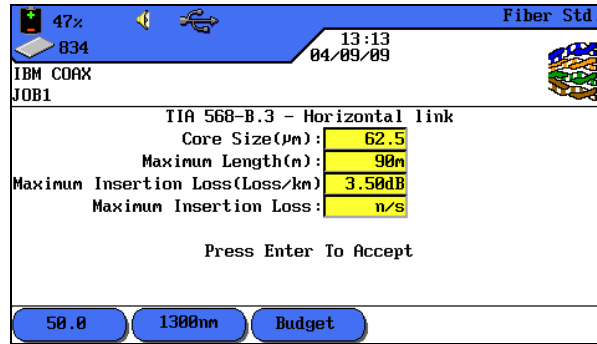

Illustration 3 8.11.2. Fiber Standard

5. If you want to keep the loss budget, confirm with **Enter**, or use soft key **Budget** to open the menu to determine the loss budget.
6. Use soft key **Budget** to open the menu to determine the loss budget.
7. Use soft keys **850nm, 1300nm, 1310nm and 1550nm** to select the according wavelength to specify the loss budget.

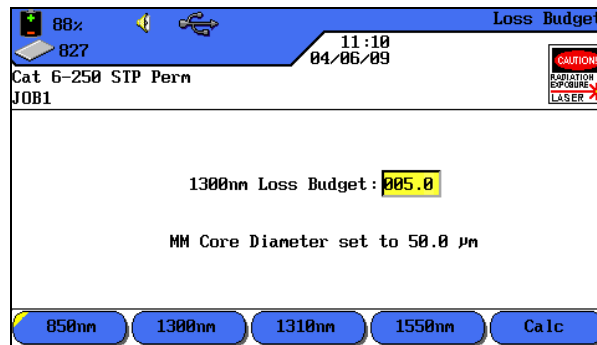

Illustration 4 8.11.2. Manual Specification of Loss Budget

NOTE:

Refer to chapter Specifications in this instruction manual to find an overview of cabling standards and application requirements for the installation of fibers.

The current limit for the loss is displayed in box *Limit*.

8. If you want to keep the value, confirm with **Enter**, or use soft key **Calc** to open input box for loss budget.
9. Use **Up/Down Arrow Keys** to navigate to individual boxes and use **alphanumeric** keys to enter details concerning the fiber line.

Length (m)	>	Loss/km
Fusion splices: Number	>	Loss
Connector Pairs: Number	>	Loss
Mechanical splices: Number	>	Loss

88% B27 11:22 04/06/09 Loss Budget

Cat 6-250 STP Perm JOB1

Length(ft)	00100	Loss/km	01.50
Splices :Nun	00	Loss	00.30
Connector :Nun	01	Loss	00.75
Repairs :Nun	00	Loss	00.00

1300nm Loss Budget : 005.0

Calc

Illustration 5 8.11.2. Details concerning the fiber line

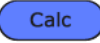
10. Use soft key  to start the calculation. The result appears in Loss Budget box.
11. To confirm, press **Enter** in this box and the next two boxes.

NOTE:

The type of soft keys indicated depends on the corresponding standard. Concerning fiber standards, refer to *Fiber Cabling Standards & Application Requirements* .

CHAPTER 9 Tone Generator

9.1. Tone Generator

The Display handset (DH) as well as the Remote handset (RH) can generate a low tone, a high tone and an alternating tone, with a rate of 2 Hz between low and high alternating tone ("Warble"), which is recognized by most standard cable locators.

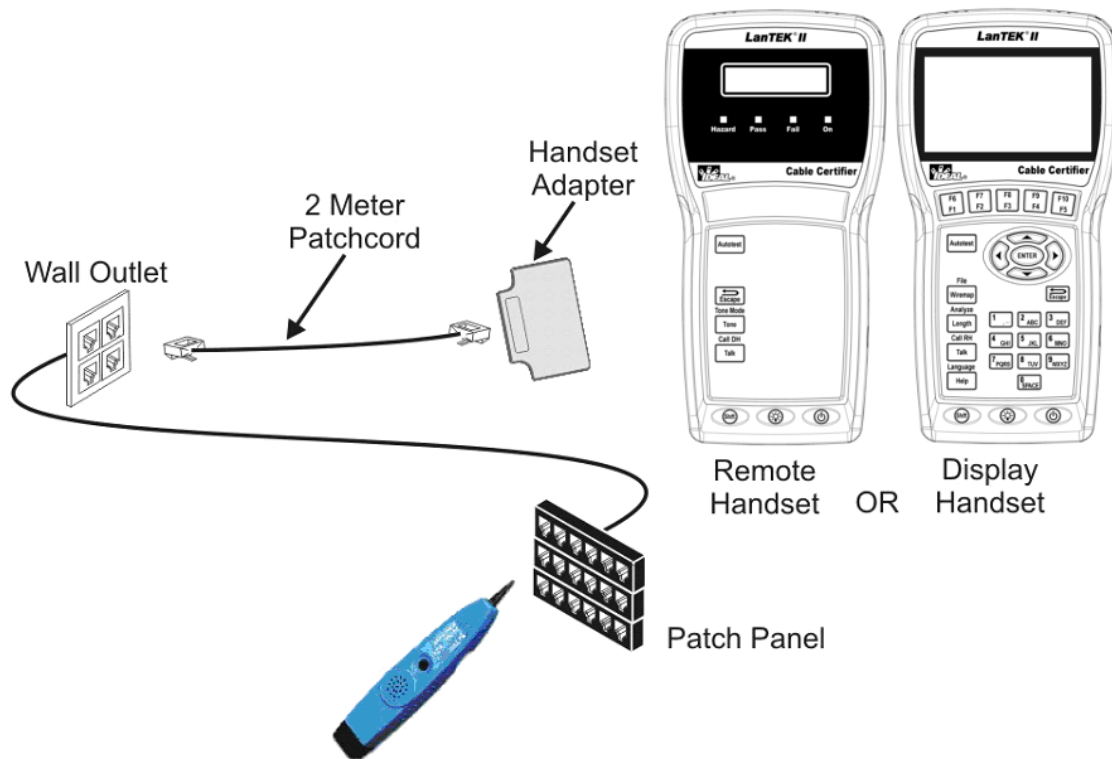

Illustration 9.1. Typical Application of Tone Generator

NOTE:

The keys **WIREMAP**, **SHIFT** and **TONE** are hard keys. The keys **Pair A**, **Pair B**, **Pair C**, **Pair D**, **Low**, **High** and **Warble** are soft keys that are displayed on the Display handset (DH).

9.1.1. Enable Tone Generator with Display handset (DH)

1. Connect Display handset (DH) to cable to be tested.
2. Use **Arrow Keys** to navigate on ready screen to "Toner" display and confirm with **Enter**.

NOTE:

The Tone Mode remains enabled until you press Escape.

3. Use soft keys to select the wire pair (Pair 78, Pair 36, Pair 54 or Pair 12) into which the tone signal is to be fed.
4. Press **SHIFT** to select tone signal and enable it with soft keys LOW, HIGH or WARBLE.

9.1.2. Enable Tone Generator with Remote handset (RH)

1. Connect Remote handset (RH) to cable to be tested.
2. On Remote handset (RH) press *TONE*. The tone mode is enabled. The first line of the two-line Remote handset (RH) display shows the message *TONE*. In the second line, the type of tone signal as well as the feed location is shown in XY format.

X symbol (Tone)	Y symbol (feed location)
L = Low	78 = Pair 78
H = High	36 = Pair 36
W = Warble	54 = Pair 54
	12 = Pair 12

Example: L78 = low tone ("Low"), pair 78

NOTE:

The Tone Mode remains enabled until you press Escape.

3. Select the wire pair into which the tone signal is to be fed by switching between the options with the **TONE** key.
4. Select the tone signal for the selected wire pair by switching between the options with **<SHIFT>+TONE**.

CHAPTER 10

IDEAL DataCENTER Software

The software included permits test record management on your computer and Firmware-Update of your LanTEK®II Cable Certifier. For this purpose, the program **IDEAL DataCENTER**, the PDF Writer **bioPDF** and the program **LanTEK Firmware-Upgrade** are installed on your computer.

10.1. Installing Software

To install the software on your computer and set up the IDEAL DataCENTER, make use of the following description.

10.1.1. System Requirements

- Microsoft Windows XP/Vista
- Minimum processor (CPU) 300 Mhz Pentium
- Minimum random access memory (RAM) 128 MB
- Minimum available hard drive space 100 MB
- Minimum graphic card Resolution 1024 x 768

10.1.2. Start Installation

The software components are installed by the supplied CD-ROM, using the standard installation program of your Windows operating system.

5. Insert the CD-ROM and start your CD-ROM drive, if necessary.
6. Start installation.
7. Follow the instructions of the installation program. It is recommended to use the default options.
8. The program IDEAL DataCENTER, the PDF-Writer bioPDF and the program LanTEK Firmware-Upgrade are installed.
9. Follow the instructions until installation of all three (3) components is finished.

The start symbols will appear on your computer desktop



Data CENTER and



LanTEK Firmware-Upgrade.

The directories DataCENTER and LanTEK Firmware-Upgrade are stored in your IDEAL Industries program file as subprograms.

```
c:\Programme\IDEAL Industries..\
                                ..\IDEAL DataCENTER
                                ..\LanTEK Firmware-Upgrade
```

NOTE:

The hard drive information (example c:\..) depends on the designation of the hard drive used with the computer.

The PDF-Writer bioPDF is installed together with the IDEAL DataCENTER program. In the printer and fax directory, the **IDEAL PDF** printer is indicated.

10.2. Select Language

Use menu button **Options** and function **Language** to change the displayed language, depending on available fonts.

10.3. Software-Update

The software of IDEAL DataCENTER should be updated to the latest software version in regular intervals. If you register for the Newsletter on the website of IDEAL INDUSTRIES, INC., you will automatically receive information on new downloads.

10.3.1. Retrieve Version

1. From the menu bar, select **Help** and next **About**.



Illustration 10.3.1. Retrieve Software Version

10.3.2. Perform Update

1. From the menu bar, select **Help** and next **Software-Updates** a connection is established to the website of IDEAL INDUSTRIES, INC., where the latest software version of the IDEAL DataCENTER is available to you.
2. Follow the instructions on the website until download is finished.

NOTE:

Together with the software version of the IDEAL DataCENTER, the latest Firmware-Upgrade for the LanTEK®II Cable Certifier is automatically downloaded and made available in the LanTEK Firmware-Upgrade program.

10.4. Databases

To store the test records of the LanTEK®II Cable Certifier, the IDEAL DataCENTER program requires a database. For initial storage of test records, a new database must be created.

10.4.1. Create a new database

1. Open the IDEAL DataCENTER program with the start symbol  **DataCENTER**.
2. Click on **New Project**, or on **File** in the menu bar and then on **New Project**.

A dialog box opens, indicating the path and the new database. The database can be identified by the ending .sdf.

e.g. c:\Programme\IDEAL Industries\IDEAL DataCENTER\Projects\IDCProject.sdf

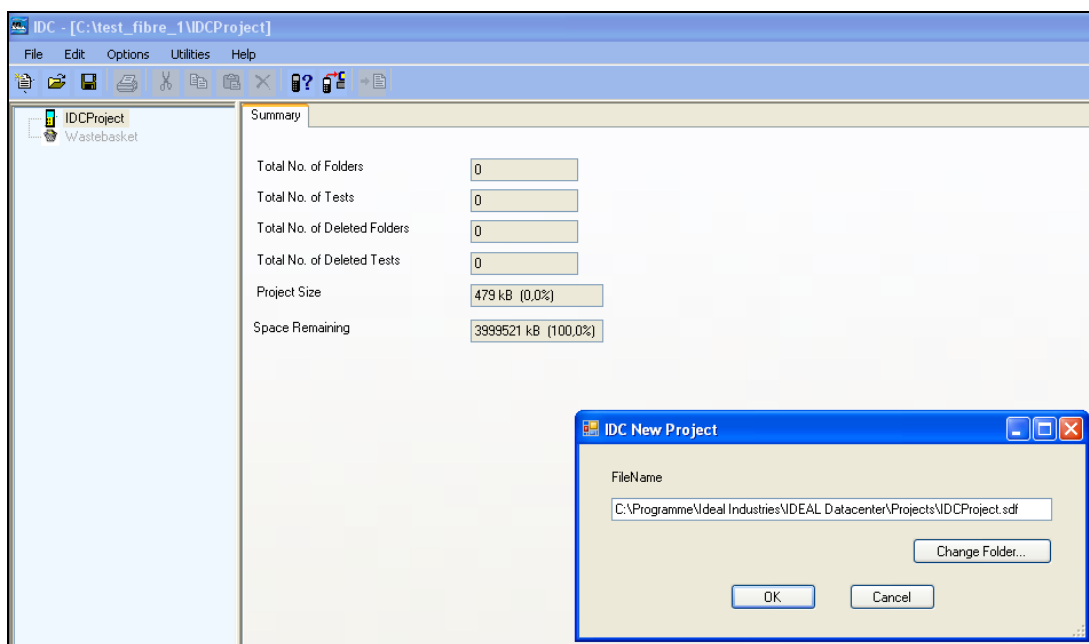

Illustration 10.4.1. Create a new database

3. You can either select the existing path or a new path by choosing **Change Folder**.
4. We suggest assigning a name to each new database (e.g. customer name, internal job name, etc.).

NOTE:

We recommend creating the database locally on the computer.
The .sdf ending of the database must be maintained.
The database cannot be renamed at a later time.

5. Click **OK** to confirm entry.

The new database with its assigned name appears on the left side of the box. The path to the database is shown in the top window bar.

NOTE:

**We recommend creating a new project for each customer.
For safety purposes, the databases should be backed up in regular intervals, e.g. on a removable media.**

10.4.2. Open an existing database

When starting IDEAL DataCENTER, the database used last is loaded.

To open another database:

1. Click on **Open Job**, or on **File** in the menu bar, and then on **Open**.

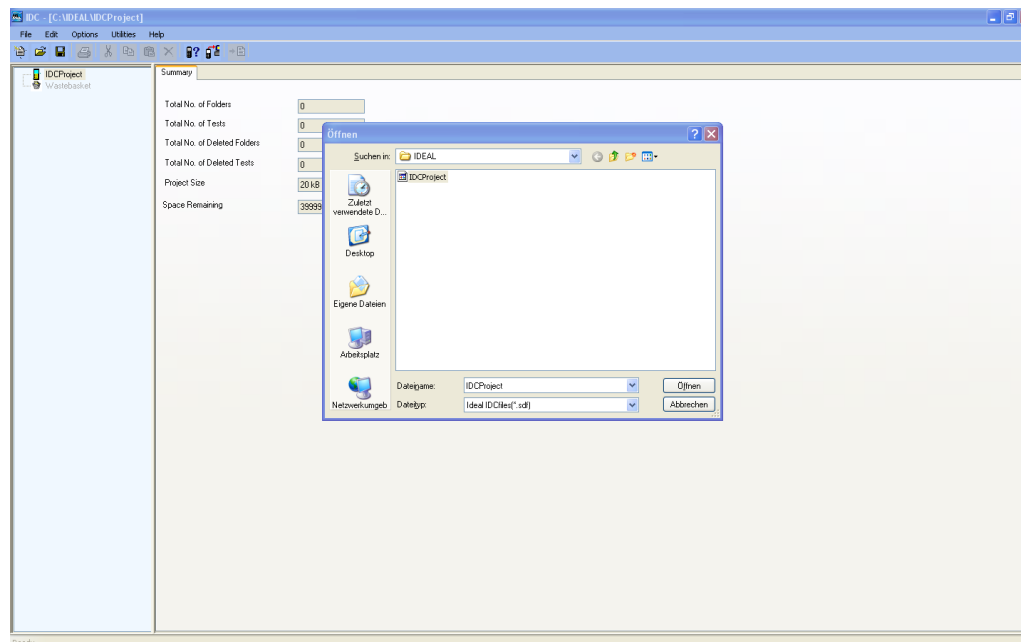

Illustration 10.4.2. Open an existing database

2. In the open dialog box, navigate to the desired database (.sdf) and make selection.
3. Confirm with **Open**.

The selected database appears in the left side of the box. The path to the database is shown in the top window bar.

The content of the database appears in the right side of the box.

10.5. Transfer job file

The job files containing test records can be directly transferred to a database by the LanTEK®II Cable Certifier, the computer or an external data carrier.

10.5.1. Upload from LanTEK®II Cable Certifier

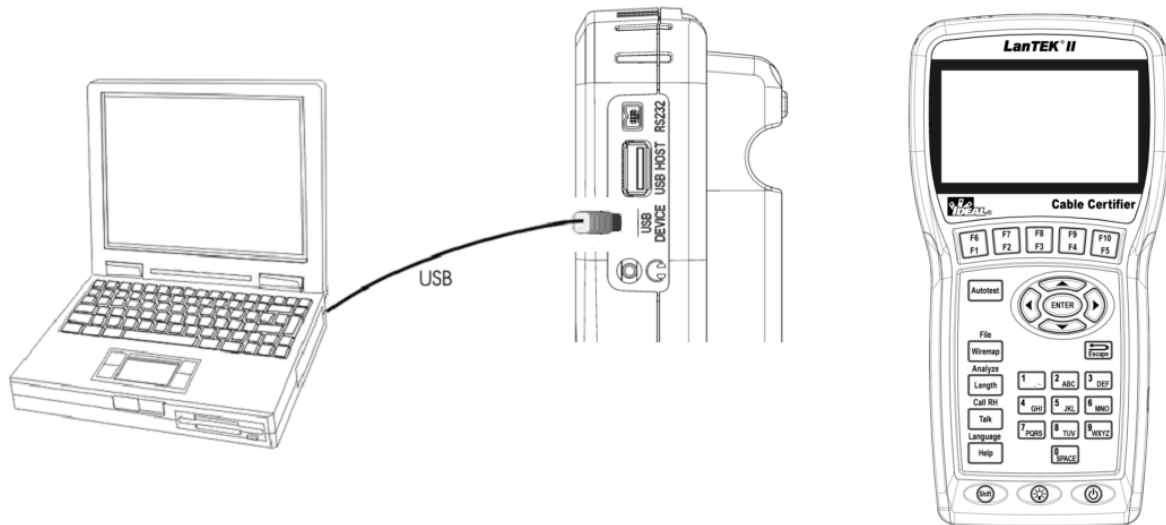



Illustration 1 10.5.1. Transfer test records from LanTEK®II Cable Certifier

1. Connect the Display handset (DH) to a free USB port of the computer by using the USB cable supplied with the LanTEK®II Cable Certifier.
2. Power the Display handset (DH) on.
3. Open the IDEAL DataCENTER program.
4. Click on  **Find Tester**. The Display handset (DH) is searched for and displayed.
5. Click **OK** to confirm the tester found.
6. Click on  **Upload** or on **File** and then on **Test Upload**.

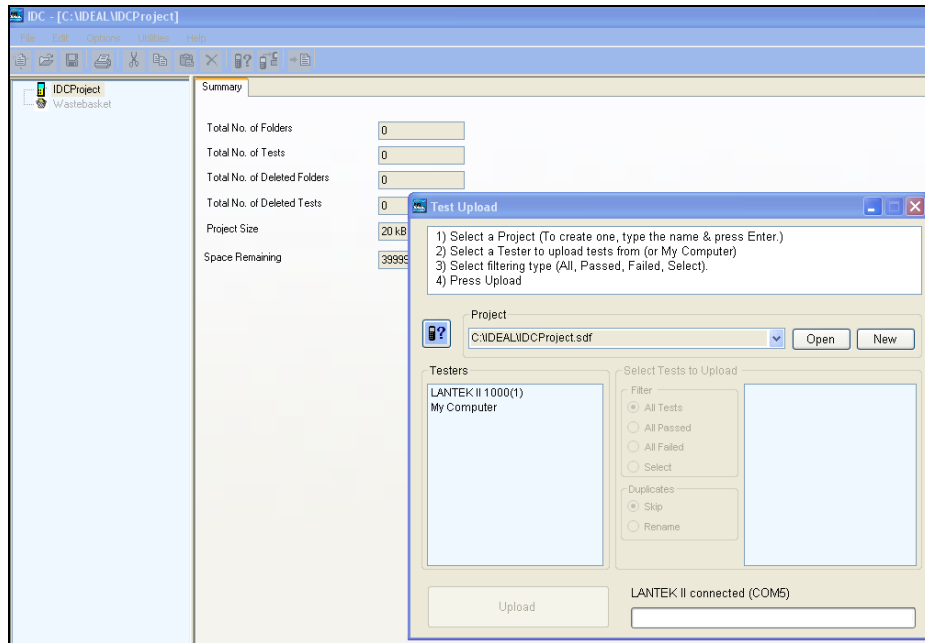

Illustration 2 10.5.1. Upload job folder with test records

7. Create a new database by clicking on database icon **New**.
8. Define the location.
9. Assign a name to the new database.
10. Select the tester and click on **Upload**.
11. Confirm creation of a backup copy (in ZIP format).

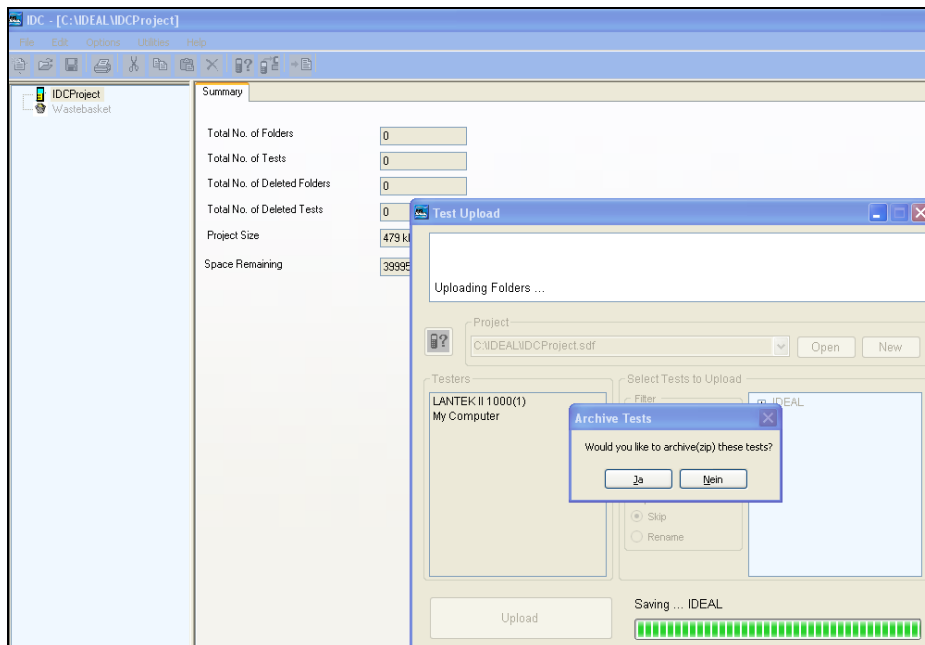

Illustration 3 10.5.1. Create a backup copy

12. Confirm with **OK**.

The new database appears in the left side of the box and the transferred job folder(s) as subfolders of the database.

NOTE:

In the folder with the new database, an additional "Upload" folder is created, in which a backup copy of the downloaded test records is saved.

10.5.2. Import from the computer or an external data carriers (USB Flash Drive)

1. Select an existing database (.sdf) or create a new database.
2. In the menu bar, click on **File**, then on **Import** and **Tests**.

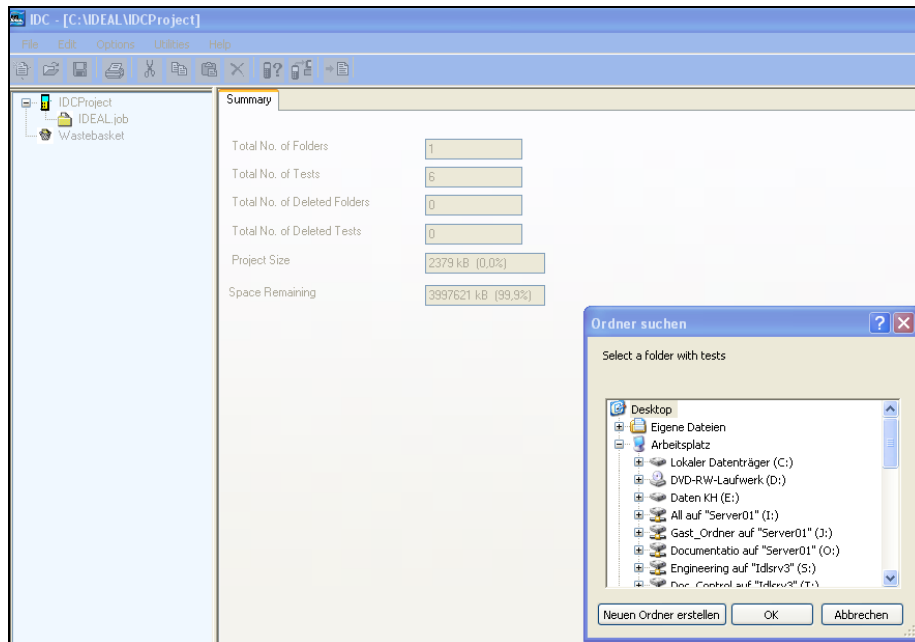

Illustration 10.5.2. Import job folder

3. In the open dialog box, navigate to the desired job folder and make selection.
4. Confirm with **OK**.

The imported job folder appears in the left side of the box as subfolder of the database.

NOTE:

Same as when uploading LanTEK®II Cable Certifier, the desired job folder can also be transferred to a database using the "Upload Test" box.

10.5.3. Export job folder

It is possible to export the content of a job folder in CSV format as list, or in XML format as report, and to further edit the records (e.g. with Excel).

1. Select the job folder to be exported in the view appearing in the left side of the box.
2. Click on **Export**.

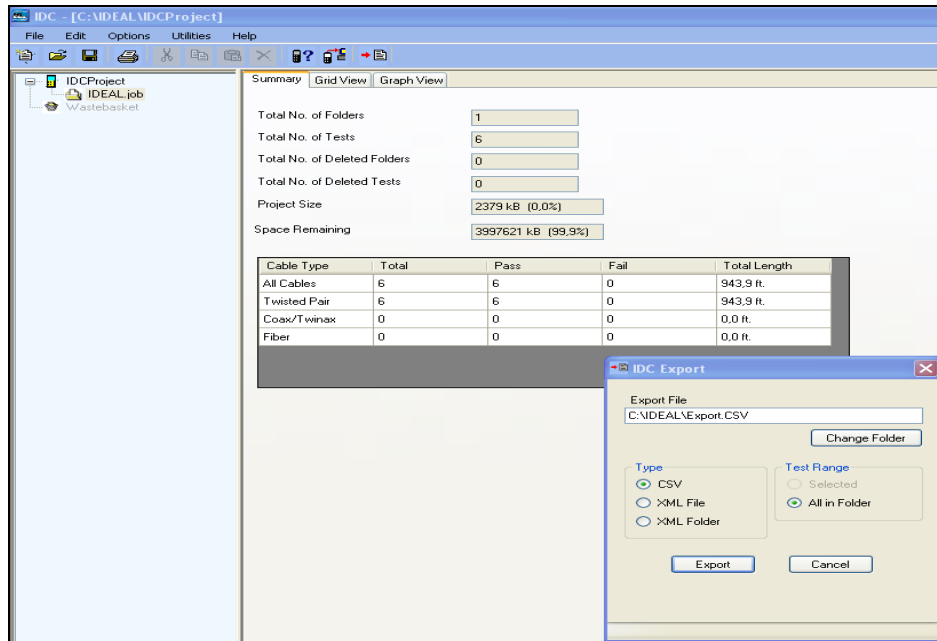

Illustration 10.5.3. Export job folder

3. You can either select the existing path or a new path by choosing **Change Folder**.
4. Under **Type**, highlight
 - CSV** if the test records of the tests stored in the job folder shall be displayed as list.
 - XML File** if all tests in the job folder shall be displayed in one (1) report.
 - XML Folder** if one (1) report shall be created for each test in the job folder. The XML files are stored in a shared folder.
5. Confirm with **OK**.

10.5.4. Rename job folder

- 1. Select the job folder to be renamed in the view appearing in the left side of the box.
- 2. Click on this job folder with the right mouse button.

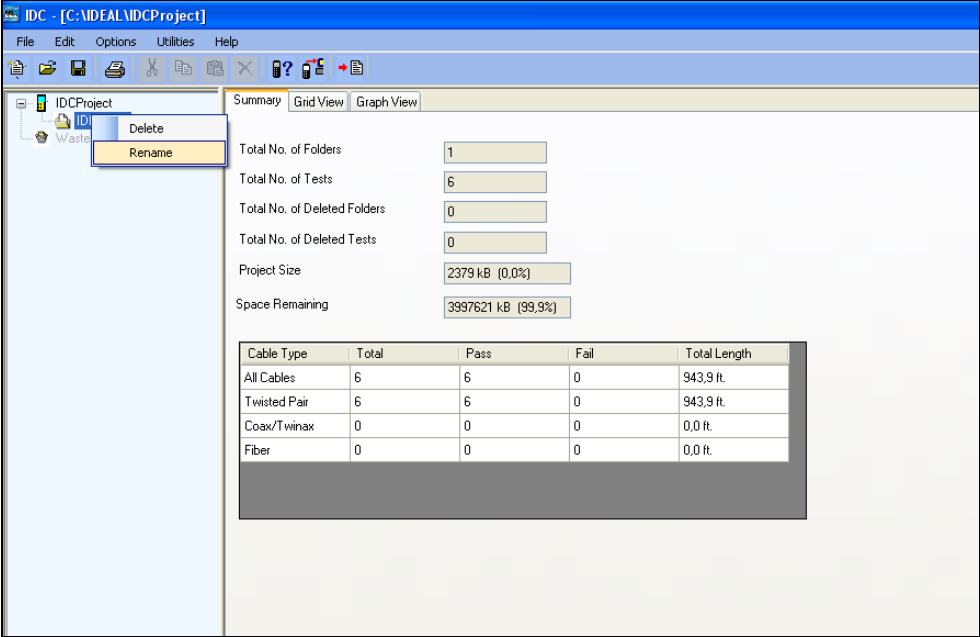

Illustration 10.5.4. Rename job folder

- 3. Assign a new file name to the job folder (e.g. building, floor, room, etc.)

10.6. Manage Tests

The tests stored in the job folder appear in the right side of the box. In **Overview**, the tests appear as summary, in **Table View** with test records, or in **Graph View** with all test details of the individual measurements.

10.6.1. Edit information

Test name, customer information and user information can be edited. It is also possible to add notes.

1. Select a job folder in the left side of the box.
2. Select **Graph View** in the right side of the box.
3. Select a test from the **Test List** and click on **Edit Test**.

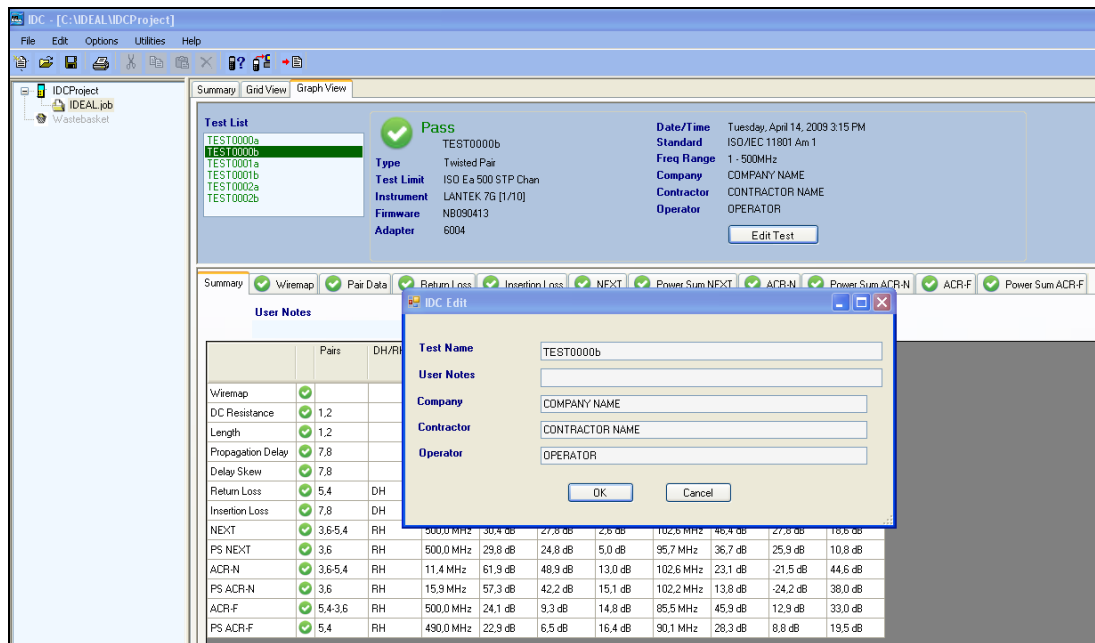

Illustration 10.6.1. Change test information

4. Perform the desired change in the open dialog box.
5. Confirm with **OK**.

The changes are saved for the test selected.

10.6.2. Edit tests and test records

In the **Table-View** individual tests and test records can be edited.

- The functions **Cut**, **Copy**, **Paste** and **Delete** are available by using the menu button **Edit** or the corresponding buttons. The tests can be copied or moved to any job folder. Deleted tests are initially sent to the wastebasket and can be restored.
- The sequence of the test records can be changed by holding a title column with the left mouse button and moving it to the desired position.
- Using the menu button **Options** and function **Grid-column**, select the test records that should be visible in the table.

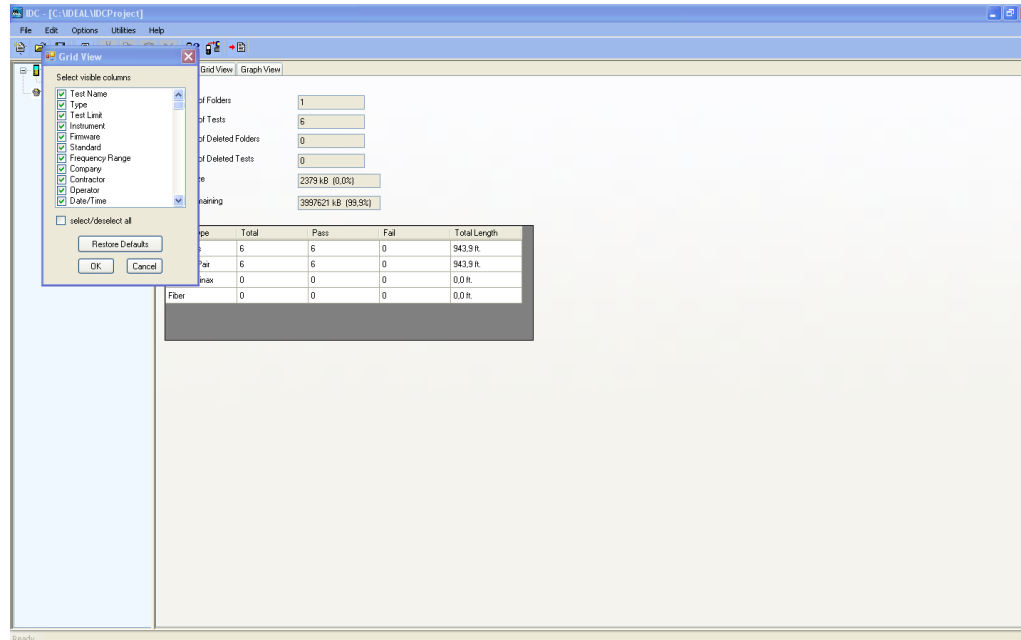

Illustration 10.6.2. Grid-column

10.6.3. Test details

The test details displayed in **Graph View** cannot be edited; only the view can be changed for analysis purposes.

- Using the menu button **Options** and function **Units**, measurement unit **Foot** and **Meter** can be selected. The displayed test details indicate the selected measurement unit and convert the measurement information.
- Using the menu button **Options** and function **Wiring**, the color scheme of the wiring can be set. The options **Default**, **568-A**, **568-B** and **TERA** are available.

10.6.4. Graphs

The graphs displayed in **Graph View** cannot be edited; only the view can be changed for analysis purposes. Graph surface, wire pair and limit value can be displayed and positioned in different ways.

1. Maximize the graph display by using the **Zoom**  function.

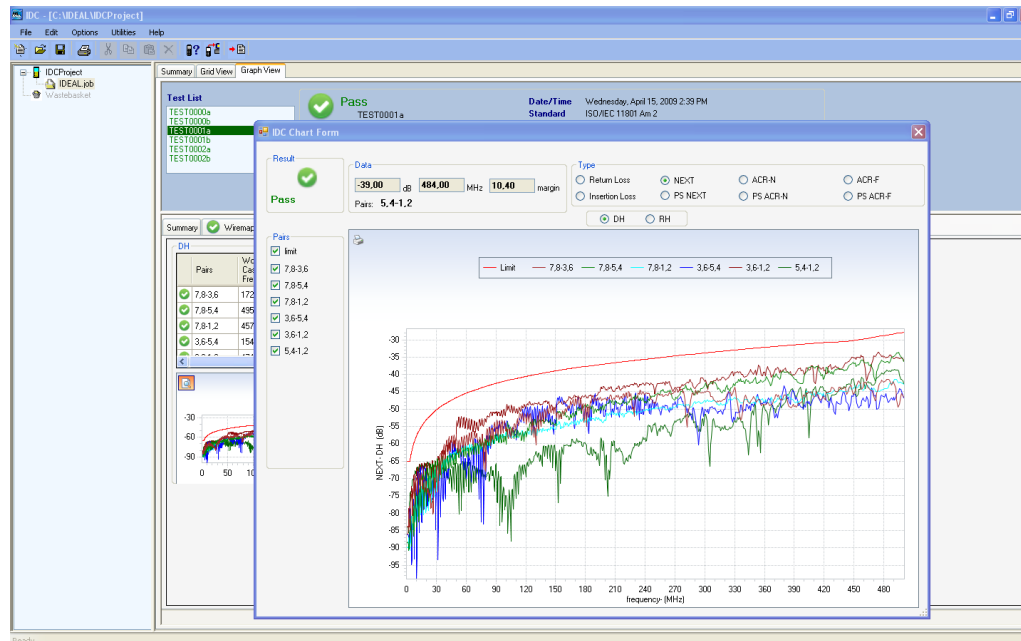

Illustration 10.6.4. Graph View

2. Click on a wire pair or limit value with the right mouse button and edit the view by using the direct commands.
3. Click in the graph surface with the right mouse button and edit the view by using the direct commands.

10.7. Produce and print reports

To create and print reports on tests and corresponding test records, use the **Print** function.

10.7.1. Set up header and footer

The report can be set up with header and footer and printed.

1. In the menu bar, click on **File** and then on **Header/Footer**.

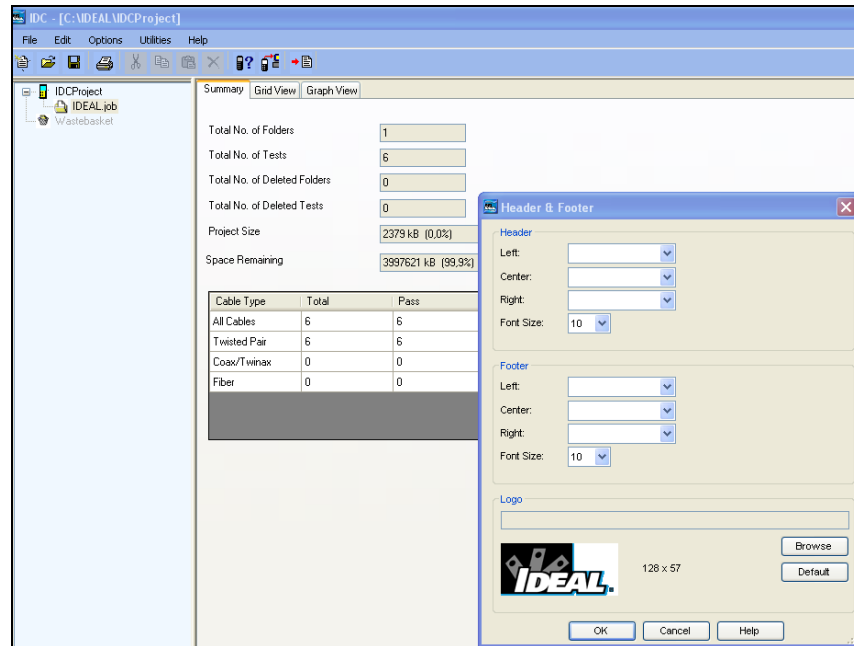

Illustration 10.7.1. Set up header and footer

It is possible to add a logo, page number, date, time or self-designed text. When selecting a logo, the location of the Bitmap file (.bmp) to be used as the logo must be provided.

2. Select the desired positions (left, right, center) in the header and/or footer and provide the desired information.
3. In the logo area, select **Search** and navigate to the desired Bitmap file (.bmp) in the open dialog box.

NOTE:

The size of the Bitmap file must be adjusted to obtain the desired size when printing the reports.

4. Confirm with **Open**. The selected Bitmap file (.bmp) and the path to the location appear in the logo area.
5. Confirm preferences with **OK**.

10.7.2. Define test selection.

A report can consist of all tests in a job folder, a selection of available tests in a job folder, or only one (1) test in a job folder.

If only one (1) test or one selection of the existing tests shall appear in the report:

1. Select the table view.
2. Click with mouse cursor on the desired test.
or
3. Combine a selection by pressing and holding the **Shift** key on the keyboard and clicking on the desired tests with the mouse cursor.

10.7.3. Print

1. Click on  **Print** or on **File** in the menu bar and then on **Print**.

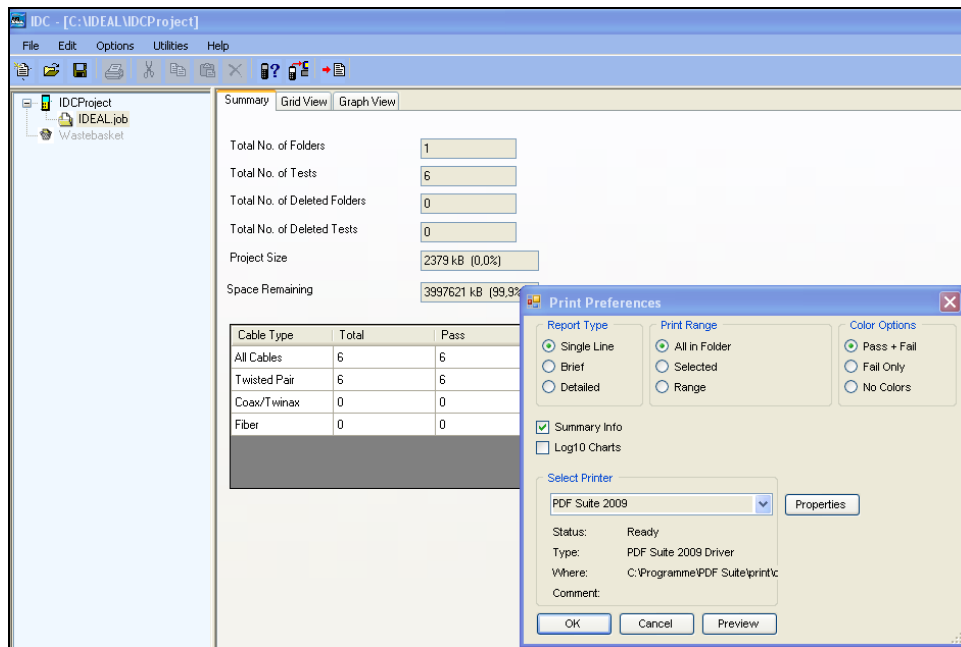

Illustration 10.7.3. Print properties

2. Under **Print range** highlight the option
 - All** if all tests in a job folder shall be displayed.
 - Selection** if you have defined a single test or a selection of tests in the table view.
 - Range** if a certain test sequence shall be displayed in the table view, e.g. tests of position 1 to position 3 (1 – 3).
3. Under **Report Type** highlight the option
 - Single Line** if the selected tests shall be displayed in a single line. The displayed test records contain cable name, length, status, date, cable type and test default.

- Brief** if a summary of test records and the corresponding graphs shall be displayed for each selected test.
 - Detailed** if all test details and the corresponding graphs shall be displayed for each selected test.
4. Under **Color Options** highlight the option
 - Passed + Failed** if passed tests shall be displayed in **green font** and failed tests in **red font**.
 - Only failed** if failed tests shall be displayed in **red font**.
 - Grayscale** if colored font shall be used.
 5. Highlight the option **Overview list** if in addition a summary of the selected tests shall be displayed.
 6. Select a printer. Perform printer settings (paper format, print quality, etc.) by using **Properties**.
 7. Confirm with **OK**.

10.8. Online Help

Use the menu button **Help** and function **Content** to establish a connection to the IDEAL INDUSTRIES, INC. website, which contains help topics.

CHAPTER 11

LANTEK Firmware Upgrade

The firmware of LanTEK® II Cable Tester should be updated in regular intervals. You can download the latest firmware upgrade from the website of IDEAL INDUSTRIES, INC. separately or together with the software update of IDEAL DataCENTER.

If you register for the **Newsletter** on the website of IDEAL INDUSTRIES, INC., you will automatically receive information on new downloads.

11.1. Perform Firmware Upgrade

Using a computer, the firmware of LanTEK® II Cable Tester can be updated with the LanTEK Firmware Upgrade program, or without a computer with a USB removable storage.

NOTE:

Before updating the firmware, make a backup of the test records on the LanTEK® II Cable Tester.

When updating the firmware, the Display (DH) or the Remote (RH) handset must be supplied with power through the adapter.

11.1.1. Using the Computer

1. Supply the Display handset (DH) with power by using the adapter.
2. Connect the Display handset (DH) to a free USB port of the computer by using the USB cable supplied with the LanTEK® II Cable Tester.
3. Power the Display handset (DH) on.

4. On the Windows desktop, select the start symbol  **LanTEK Firmware Upgrade.**

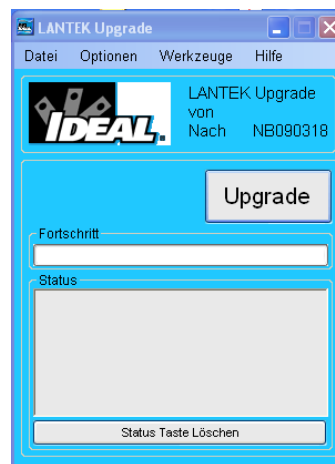



Illustration 11.1.1. LanTEK Firmware Upgrade

5. Select **Upgrade** and follow the instructions until the upgrade is finished.

NOTE:

Upgrade only newer firmware with higher end numbers.

During the upgrade, the connection to the adapter must not be interrupted.



6. Repeat with the remote handset (RH).
or
7. Supply the Remote handset (RH) with power by using the adapter.
8. Connect the Display (DH) and the Remote (RH) handset with a patch cord by using the test adapters.
9. Press **Autotest**. The Display Handset (DH) reports the version difference.
10. Open **Calibration** menu.
11. Enable firmware upgrade with .
12. Confirm update with .
13. Wait until upgrade is finished and normal operating status is displayed on Remote handset (RH).

11.1.2. Firmware Upgrade with USB Removable Storage

1. Save the firmware upgrade on an empty USB removable storage.
2. Supply the Display handset (DH) with power by using the adapter.
3. Insert the USB removable storage into the USB port of the powered off Display handset (DH).
4. Power the display handset (DH) on, wait approx. 1-2 seconds, then press and hold the **Escape** button until an hourglass appears on the TFT display. Release the escape button when the hour glass appears.
5. Wait until the upgrade is finished and the main menu appears on the Display handset.

NOTE:

During the upgrade, the connection to the adapter must not be interrupted.

6. Supply the Remote handset (RH) with power by using the adapter.
7. Connect the Display (DH) and the Remote (RH) handset with a patch cord by using the test adapters.
8. Press **Autotest**. The Display Handset (DH) reports the version difference.
9. Open **Calibration** menu.
10. Enable firmware upgrade with .
11. Confirm update with .
12. Wait until upgrade is finished and normal operating status is displayed on Remote handset (RH).

12.1. Fiber (LWL)

Summary of Fiber Optic Cabling Standards & Application Requirements

Standards Organization	Classification or Application	Fiber Type	Core size (um) / wavelength (nm)	Max Link Channel Loss (dB)	Max Connector Insertion Loss (dB)	Max Splice Insertion Loss (dB)	Min Connector Return Loss (dB)	Maximum Distance (m)	Min Operating Distance (m) (50um/62.5um)	Max Fiber Attenuation (dB/km)	Min Fiber Bandwidth (MHz-km)
TIA 568-B.3 Generic Cabling	Horizontal link	Multimode	62.5/850	n/s	0.75	0.3	>20	90	n/s	3.5	160
	Horizontal link	Multimode	50/850	n/s	0.75	0.3	>20	90	n/s	3.5	500
	Horizontal link	Multimode	62.5/1300	n/s	0.75	0.3	>20	90	n/s	1.5	500
	Horizontal link	Multimode	50/1300	n/s	0.75	0.3	>20	90	n/s	1.5	500
	Backbone	Multimode	62.5/850	n/s	0.75	0.3	>20	2km	n/s	3.5	160
	Backbone	Multimode	50/850	n/s	0.75	0.3	>20	2km	n/s	3.5	500
	Backbone	Multimode	62.5/1300	n/s	0.75	0.3	>20	2km	n/s	1.5	500
	Backbone	Multimode	50/1300	n/s	0.75	0.3	>20	2km	n/s	1.5	500
ISO 11801 Generic Cabling	Horizontal link	Single mode	9/1310	n/s	0.75	0.3	>26	90	n/s	1.0	n/a
	Horizontal link	Single mode	9/1550	n/s	0.75	0.3	>26	90	n/s	1.0	n/a
	Backbone (ISP)	Single mode	9/1310	n/s	0.75	0.3	>26	3km	n/s	1.0	n/a
	Backbone (ISP)	Single mode	9/1550	n/s	0.75	0.3	>26	3km	n/s	1.0	n/a
	Backbone - (OSP)	Single mode	9/1310	n/s	0.75	0.3	>26	3km	n/s	0.5	n/a
	Backbone - (OSP)	Single mode	9/1550	n/s	0.75	0.3	>26	3km	n/s	0.5	n/a
	OF-300	OM1	50 or 62.5/1300	1.95	0.75 ea/ 1.5 total	0.3	>20	n/s	300	1.5	500
	OF-300	OM2	50 or 62.5/850	2.55	0.75 ea/ 1.5 total	0.3	>20	n/s	300	3.5	500
ISO 11801 Generic Cabling	OF-300	OM2	50 or 62.5/1300	1.95	0.75 ea/ 1.5 total	0.3	>20	n/s	300	1.5	500
	OF-300	OM3	50/850	2.55	0.75 ea/ 1.5 total	0.3	>20	n/s	300	3.5	1500
	OF-300	OM3	50/1300	1.95	0.75 ea/ 1.5 total	0.3	>20	n/s	300	1.5	500
	OF-300	OS1	9/1310 or 1550	1.80	0.75 ea/ 1.5 total	0.3	>35	n/s	300	1.0	n/s
	OF-500	OM1	50 or 62.5/850	3.25	0.75 ea/ 1.5 total	0.3	>20	n/s	500	3.5	200
	OF-500	OM1	50 or 62.5/1300	2.25	0.75 ea/ 1.5 total	0.3	>20	n/s	500	1.5	500

Standards Organization	Classification or Application	Fiber Type	Core size (um) / wavelength (nm)	Max Link Channel Loss (dB)	Max Connector Insertion Loss (dB)	Max Splice Insertion Loss (dB)	Min Connector Return Loss (dB)	Maximum Distance (m)	Min Operating Distance (m) (50um/62.5um)	Max Fiber Attenuation (dB/km)	Min Fiber Bandwidth (MHz-km)	
ISO 11801 Generic Cabling	OF-500	OM2	50 or 62.5/850	3.25	0.75 ea/ 1.5 total	0.3	>20	n/s	500	3.5	500	
	OF-500	OM2	50 or 62.5/1300	2.25	0.75 ea/ 1.5 total	0.3	>20	n/s	500	3.5	500	
	OF-500	OM3	50/850	3.25	0.75 ea/ 1.5 total	0.3	>20	n/s	500	3.5	1500	
	OF-500	OM3	50/130	2.25	0.75 ea/ 1.5 total	0.3	>20	n/s	500	1.5	500	
	OF-500	OS1	9/1310 or 1550	2.00	0.75 ea/ 1.5 total	0.3	>35	n/s	500	1.0	n/a	
	OF-2000	OM1	50 or 62.5/850	8.50	0.75 ea/ 1.5 total	0.3	>20	n/s	2km	3.5	200	
	OF-2000	OM1	50 or 62.5/1300	4.50	0.75 ea/ 1.5 total	0.3	>20	n/s	2km	1.5	500	
	OF-2000	OM2	50 or 62.5/850	8.50	0.75 ea/ 1.5 total	0.3	>20	n/s	2km	3.5	500	
	OF-2000	OM2	50 or 62.5/1300	4.50	0.75 ea/ 1.5 total	0.3	>20	n/s	2km	1.5	500	
	OF-2000	OM3	50/850	8.50	0.75 ea/ 1.5 total	0.3	>20	n/s	2km	3.5	1500	
	OF-2000	OM3	50/130	4.50	0.75 ea/ 1.5 total	0.3	>20	n/s	2km	1.5	500	
	OF-2000	OS1	9/1310 or 1550	3.50	0.75 ea/ 1.5 total	0.3	>35	n/s	2km	1.0	n/a	
	IEEE 802.3	10Base-FL	Multimode/ OM1-OM2	62.5/850	12.50	0.75 ea/ 1.5 total	n/s	>20	2km	0	3.75	160
		10Base-FL	Multimode/ OM1-OM3	50/850	12.50	0.75 ea/ 1.5 total	n/s	>20	1.5km	0	3.75	160
		100Base-FX	Multimode/ OM1-OM3	62.5 or 50/1300	11.00	0.75 ea/ 1.5 total	n/s	n/s	2km	0	3.75	500
1000Base-SX		Multimode/ OM1-OM2	62.5/850	2.33	0.75 ea/ 1.5 total	n/s	>20	n/s	220	3.75	160	
1000Base-SX		Multimode/ OM2-OM3	62.5/850	2.53	0.75 ea/ 1.5 total	n/s	>20	n/s	275	3.75	200	
1000Base-SX		Multimode/ OM1-OM3	50/850	3.25	0.75 ea/ 1.5 total	n/s	>20	n/s	500	3.5	400	
1000Base-SX		Multimode/ OM2-OM3	50/850	3.43	0.75 ea/ 1.5 total	n/s	>20	n/s	550	3.5	500	
1000Base-LX		Multimode/ OM1-OM2	62.5/1300	2.32	0.75 ea/ 1.5 total	n/s	>20	n/s	550	1.5	500	
1000Base-LX		Multimode/ OM1-OM2	50/1300	2.32	0.75 ea/ 1.5 total	n/s	>20	n/s	550	1.5	400/500	
1000Base-LX		Singlemode/ OS1	9/1310	4.50	0.75 ea/ 1.5 total	n/s	>26	n/s	5km	0.5	n/a	
10GBase-SR		Multimode- OM1	62.5/850	2.60	0.75 ea/ 1.5 total	n/s	>20	n/s	26	3.5	160	
10GBase-SR		Multimode- OM1	62.5/805	2.50	0.75 ea/ 1.5 total	n/s	>20	n/s	33	3.5	200	
10GBase-SR		Multimode/ OM2-OM3	50/850	2.20	0.75 ea/ 1.5 total	n/s	>20	n/s	66	3.5	400	

13.1. Technical Support

For technical support in the US and Canada, or questions about Service, call IDEAL INDUSTRIES at 1-800-854-2708 or 858-627-0100. To order parts or accessories call 800-435-0705.

13.2. Service in the US

To comply with precision requirements, you should have your LanTEK®II Cable Tester calibrated on an annual basis. Before sending the tester for calibration or maintenance, please contact the Technical Customer Service of IDEAL INDUSTRIES, INC. in the US at 1-800-854-2708 or /858-627-0100.

NOTE:

If cleaning is required, please use a soft cloth and a mild cleaning agent, suitable for plastic. Do not submerge tester in water.

When returning testers for service or calibration:

1. Obtain an RMA number from customer service.
2. Use a solid shipping box. We recommend a double-wall box made of stiff cardboard.
3. Wrap the tester 70 - 100 mm on all sides with shock-absorbing material to ensure a solid cushion, and to keep the tester from moving inside the packaging.
4. Ensure that shipping box is securely sealed.

Send the tester, free of charge, to:
IDEAL INDUSTRIES Corporation
9650 Chesapeake Drive
San Diego, CA 92123
ATTN: RMA # XXX

The costs for the return of the tester via UPS ground service to customers in the US (Mainland) are borne by IDEAL INDUSTRIES.

13.3. Service outside the US

If you need technical support outside the US and Canada, or have questions about Service, please contact your local agency.

For sustainable compliance with precision requirements, you should have your LanTEK®II Cable Tester calibrated on an annual basis. Before sending a tester for calibration or maintenance outside the US, please contact your local agency or one of the subsidiaries of IDEAL INDUSTRIES listed below. If your local agency does not offer this service, it can assist you in sending the tester to an authorized Service Office of IDEAL Industries, INC.

North/South America

IDEAL INDUSTRIES Corporation
9650 Chesapeake Drive
San Diego, CA 92123
Tel: 800-854-2708/ 858-627-0100
Fax: 858-715-7003

Europe (Germany, France, Italy, Austria, Eastern Europe, Portugal, Switzerland, Spain, MEA)

IDEAL INDUSTRIES GmbH
Gutenbergstrasse 10
85737 Ismaning, Germany
Tel: +49-89-99686-0
Fax: +49-89-99686-111
E-mail: Ideal_Germany@idealindustries.com

Great Britain (Belgium, Denmark, Finland, Iceland, Luxemburg, Netherlands, Norway, Sweden)

IDEAL INDUSTRIES (U.K.) Limited
UNIT 3, EUROPA COURT
EUROPA BOULEVARD
WESTBROOK
WARRINGTON WA5 7TN
CHESHIRE ENGLAND
TEL: +44-1925-444446
FAX: +44-1925-445501
E-mail: Ideal_UK@idealindustries.com

China

IDEAL Industries China, L.L.C.
Unit 911, Tower W1, Oriental Plaza
No. 1 East Chang An Avenue, Dongcheng District
Beijing, 100738, China
Tel: +86-010-85183141
Fax: +86-010-85183143
E-mail: support@idealindustries.cn

Brazil

IDEAL INDUSTRIES BRASIL LTDA.
America Business Park
Av. Marginal do Rio Pinheiros,
05200 - 201/F - 05693 - 000 -
Sao Paulo - SP - Brazil
Telephone (main) +55-11-3759-8777
Telephone (tech support) +55-11-3759-8776
Fax: +55-11-3759-8775
E-mail: Brazil@idealindustries.com

Mexico

IDEAL Industries Mexico
Parque Intermex
Periferico Sur 7999 A
Col. Sta. Ma. Tequepexpan
Tlaquepaque, Jalisco 45601
Mexico
Tel: +52-33-37702320
Fax: +52-33-37702300

Australia

IDEAL Industries (Australia) PTY.Limited
Level 6
75-85 Elizabeth Street
Sydney NSW 2000 Australia
Tel: 61300-765-800 (Australia)
Tel: 61405-123-100 (New Zealand)
Fax: 61300-765-801

13.4. Internet

IDEAL INDUSTRIES, INC. has created a website for LAN cable test products, from which you can download the latest information on cable test applications, as well as Firmware upgrades via your computer and a modem. A Question & Answer Forum gives you the option to exchange information with other users and to submit questions to IDEAL INDUSTRIES, INC.

<http://www.idealindustries.com>