

WALL MOUNT ENCLOSURE 600 SERIES E-Z Compact



Width 20.5" - Depth 20"

Features:

- ▶ Packaged broken down in an easy to carry space saving carry box.
- ▶ Vented front and top panels.
- ▶ Designed with internal mounting cage nut rails for #12-24 mounting screws in accordance with EIA standards.
- ▶ Comes complete with equipment mounting hardware and one pre-installed ventilation 80 cfm fan.
- ▶ Front door can be reversible for left or right side opening. Key lock.
- ▶ Meets or exceeds EIA-310D standards.
- ▶ Electrostatic microfinish paint.



Mounting Holes



Help installers to easily mount the unit to the wall.

Guide Slot



Allows a perfect alignment for the side panels.

Cable Access



Top and bottom panels features cutouts for cable access and ventilation fan.

Easy Carry Box

Space Saving



Easy to carry



Compact



Colors:



Black



Ivory

Custom colors and configurations available. Minimum quantities apply.



WALL MOUNT ENCLOSURE 600 SERIES E-Z Compact

Width 20.5" - Depth 20"

Specifications					AWG				
Stock No.	Height	Format	RU	Color	Rear Panel	Top Panel	Bottom Panel	Side Panels	Front Door
EZ19-07-01	15"	19"	7 RU	Ivory	16	18	18	18	20
EZ19-07-02	15"	19"	7 RU	Black	16	18	18	18	20
EZ19-09-01	18"	19"	9 RU	Ivory	16	18	18	18	20
EZ19-09-02	18"	19"	9 RU	Black	16	18	18	18	20
EZ19-11-01	22"	19"	11 RU	Ivory	16	18	18	18	20
EZ19-11-02	22"	19"	11 RU	Black	16	18	18	18	20

RU = Rack Units

External Dimensions

Product					Package			
RU	A - Height	B - Width	C - Depth	Load Capacity	Height	Width	Depth	Shipping Weight
7 RU	15"	20.5"	20"	45 lbs	4.5"	23"	22.5"	34 lbs
9 RU	18"	20.5"	20"	65 lbs	4.5"	23"	22.5"	36 lbs
11 RU	22"	20.5"	20"	85 lbs	4.5"	23"	22.5"	38 lbs

Internal Dimensions

Product				
RU	A - Height	B - Width	C - Depth	Load Capacity
7 RU	12.25"	19"	15"	45 lbs
9 RU	15.75"	19"	15"	65 lbs
11 RU	19.25"	19"	15"	85 lbs

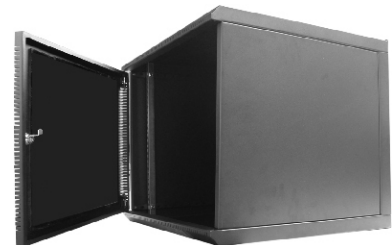
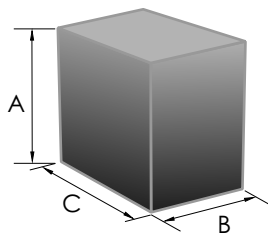
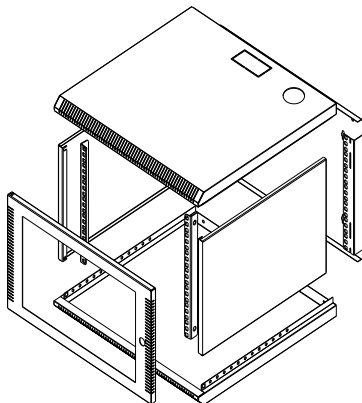

WALL MOUNT ENCLOSURE 600 SERIES

E-Z ASSEMBLY

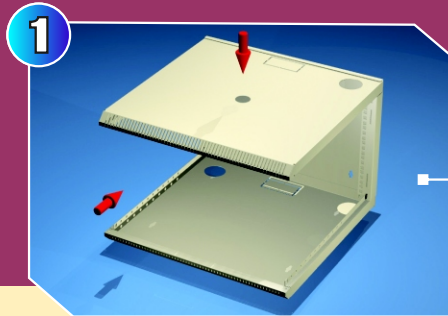

1 Install top and bottom panels by tightening the nuts on the rear panel.

Pre-position for desired equipment depth and install left and right rails.

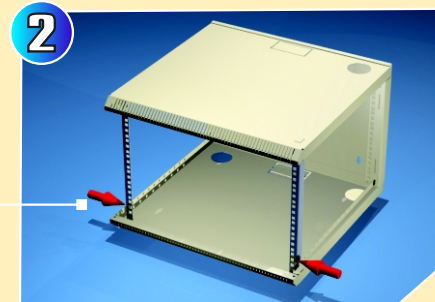

2 Install the left and right panels with the supplied mounting screws.

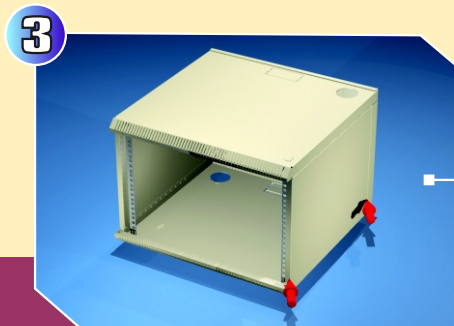

3 Install the front door by aligning with the corresponding side panel; right or left hand opening.

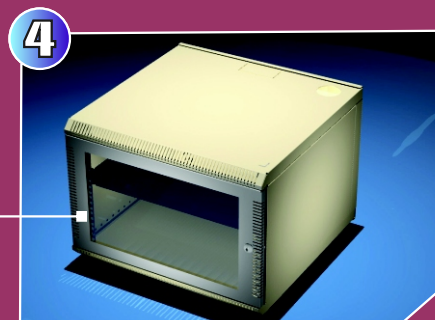

MOUNT ENCLOSURE TO THE WALL