

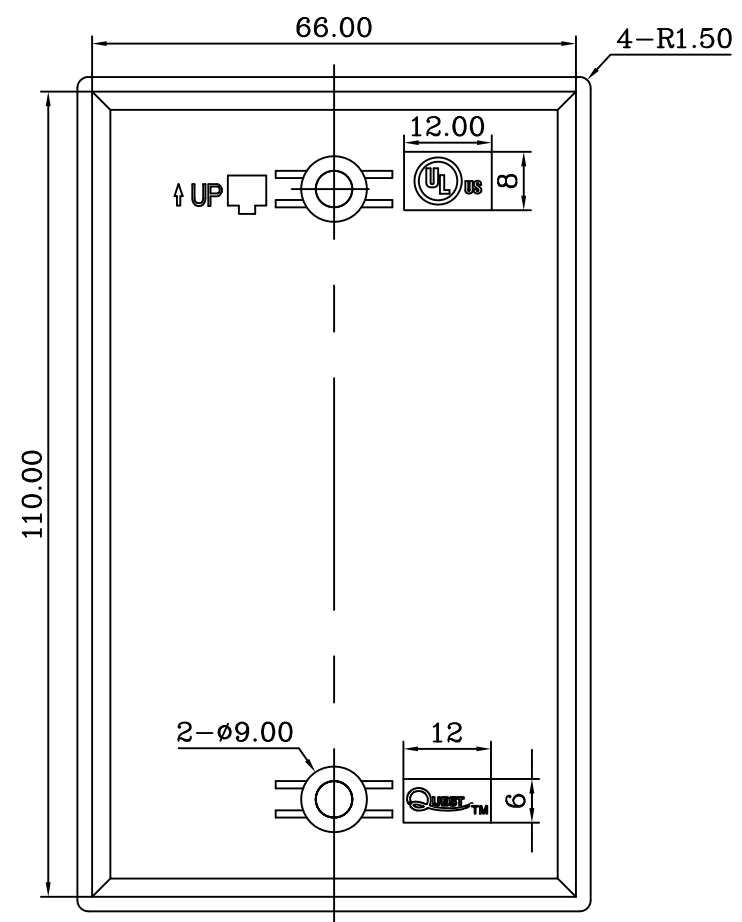

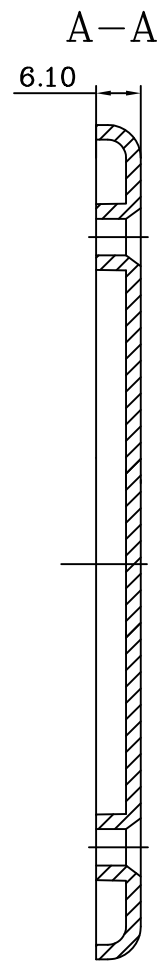

REVISIONS				
ZONE	REV	DESCRIPTION	DATE	APPROVED

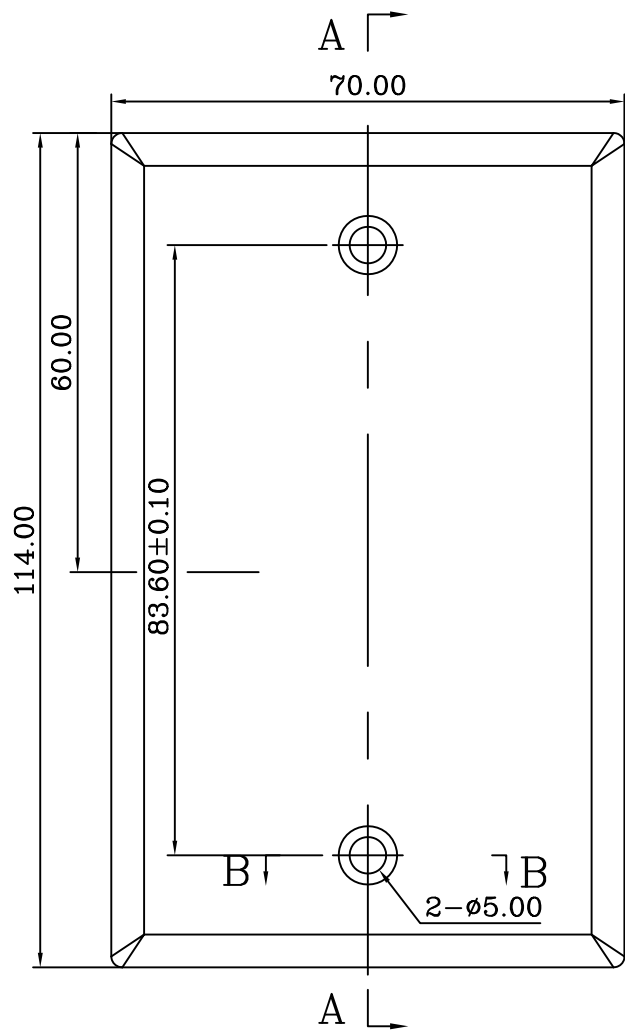

ENCLOSURE: K4.6 x 25mm SCREW X 2 
 screw head color matches wall plate color

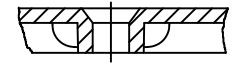
B-B

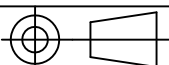

Scale	1:1	 Quest Technology Int'l, Inc 11200NW 138th st, Medley, FL33178							
3rd Angle Projection									
Unit	mm	Part no. NFP-100X							
Date	2011.12.19	KEYSTONE WALL PLATE, -							
Tolerance		Title: BLANK, UL							
NFP-1007	Ivory	Drawn by	Checked by	Drawing No.					
NFP-1008	White	~20 ±0.2	~50 ±0.4	~150 ±0.5	150~ ±1.5	ALGLE 2°	黃体味		