

GREAT LAKES RACK PDU SPECIFICATION

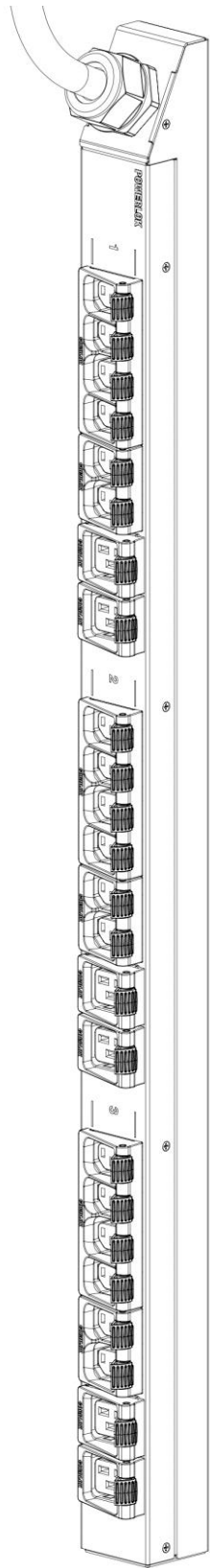

Specific Configurations

COLOR	CARBON		RED		WHITE		BLUE	
WHIP LENGTH	6 FT	10 FT	6 FT	10 FT	6 FT	10 FT	6 FT	10 FT
BASIC MODEL	GL8725B-06C	GL8725B-10C	GL8725B-06R	GL8725B-10R	GL8725B-06W	GL8725B-10W	GL8725B-06B	GL8725B-10B
DESCRIPTION	RACK PDU, 36", 20A 240/415V WYE 3PH, 21-C19, IEC 309 (IP44), CORDLOK							
MONITORING	NONE							
SWITCHING	NONE							
POWER	20A 240/415V WYE 3PH (11.5 kW)							
PLUG TYPE	IEC 309 (IP44)							
UNIT LENGTH	36 INCHES							
RECEPTACLES	21-C19							
CORDLOK	YES							

Universal Specification

Over Current Protection	None
Power Whip	See PDU Ratings Table - page 2
Heavy Steel - Powder Coat Color	Per PowerLok specific configuration for color
Rack PDU Type	Vertical Rack-mount
Toolless Mounting: Center Spacing	24.50"
Manufactured in the USA	Yes
Product Warranty	3-year from date of shipment, repair or replace.
Certification/Agency Approvals	TUV Certified to UL/CSA 60950-1 with NOM Addendum for Mexico, FCC Part 15 Class A conformance, RoHS compliant
Operating Environment	0-60C (32-149F), 5-95% relative humidity, 0-10,000ft (0-3000 meters) elevation.
Storage Environment	-25-65C (-13-149F), 5-95% relative humidity, 0-10,000ft (0-3000 meters) elevation.
Chassis Dimensions (LxWxD)	36"L x 2.18"W x 2.0"D
Package Dimensions (LxWxD)	49.0"L x 22.0"W x 4.8"D (3&4-Pack), 49.0"L x 11.0"W x 4.8"D (1&2-Pack)
Pallet Dimensions (LxWxD)	49"L x 44"W x 5.0"D
Rack PDU Weight	11.3 lbs.
Packaged Weight (each)	13.3 lbs.

Example drawing shown. See table for actual receptacle configuration.

MADE AND ROBOTICALLY SOLDERED IN THE USA

GREAT LAKES

*CUSTOMER SIGNATURE:	DATE:	UNLESS OTHERWISE SPECIFIED, ALL DIMENSIONS ARE IN MM AND TOLERANCES ARE: X = +/- 0.5 .X = +/- 0.25 .XX = +/- 0.13 X' = +/- 0.5'	Great Lakes Data Racks and Cabinets	
*PRIOR TO MANUFACTURING, BUILD MODELS REQUIRE CUSTOMER SIGN-OFF. BY SIGNING, CUSTOMER AGREES THAT THIS ORDER IS NON-CANCELABLE AND NON-RETURNABLE.			TITLE: RACK PDU SPECIFICATION	
		DRAWING NUMBER: SP-GL8725	SHEET: 1 OF 2	
THIS SPECIFICATION AND ITS CONTENTS ARE THE PROPERTY OF GREAT LAKES DATA RACKS AND CABINETS AND SHALL NOT BE COPIED OR REPRODUCED FOR ANY PURPOSES OTHER THAN APPLICATION OF PRODUCT MANUFACTURED BY GREAT LAKES. THIS DRAWING IS SUBJECT TO CHANGE WITHOUT NOTICE.				

OUTLINE DRAWING

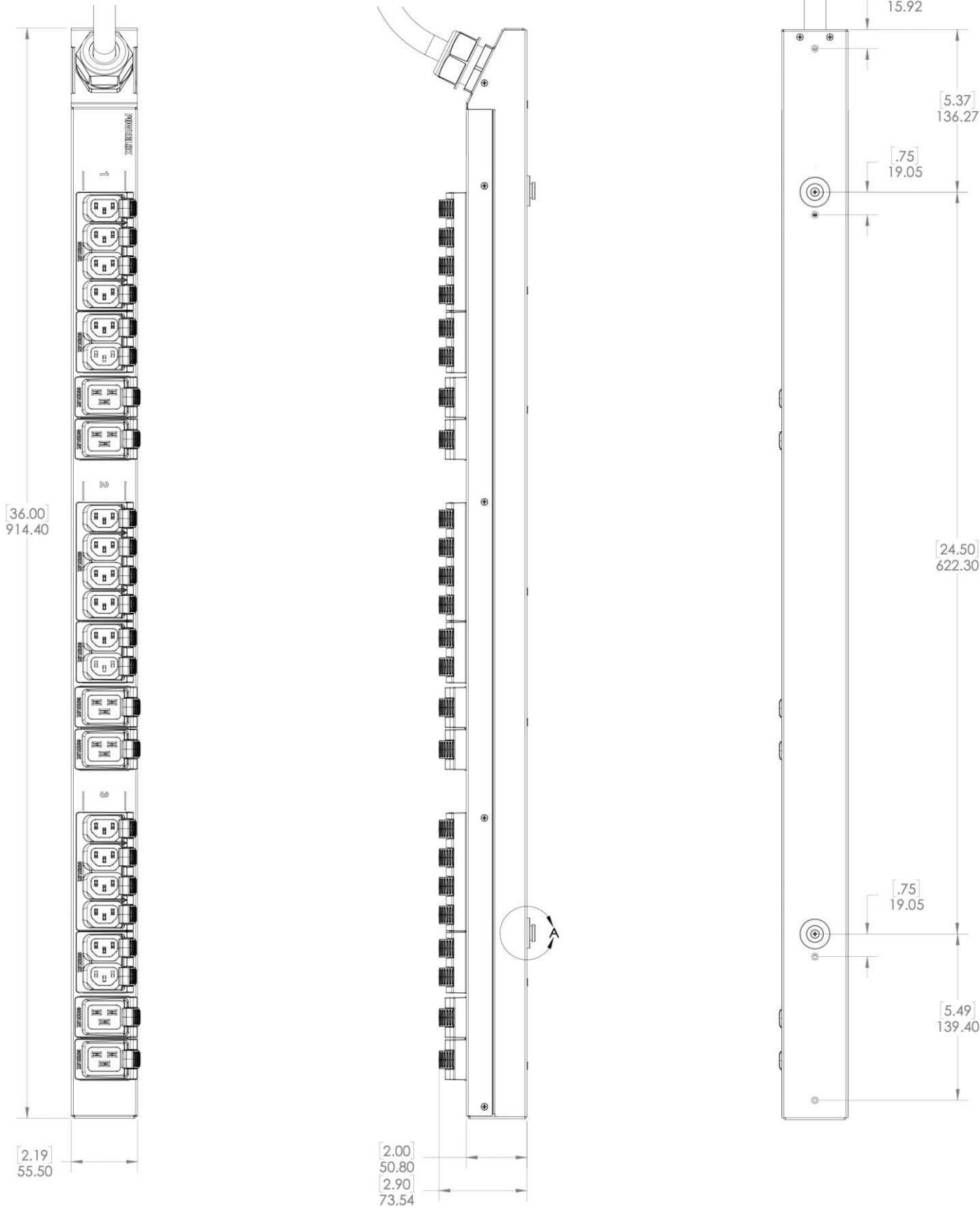

PLUG/OUTLETS
SEE CONFIGURATION TABLE FOR ACTUAL PLUG & OUTLETS

NEMA L22-20P 20A/200-415V 16A DERATED INPUT

IEC 60309 4P5W IP44 SPLASHPROOF 20A/200-415V 16A DERATED INPUT

IEC 60309 4P5W IP67 WATERTIGHT 20A/200-415V 16A DERATED INPUT

IEC 60320 C13 10A/250V INTL. & 15A/250V N.A. MAX RATED OUTPUT

IEC 60320 C19 16A/250V INTL. & 20A/250V N.A. MAX RATED OUTPUT

NEMA L6-20R . 20A/250V MAX RATED OUTPUT

PDU WIRING DIAGRAM & RATINGS TABLE

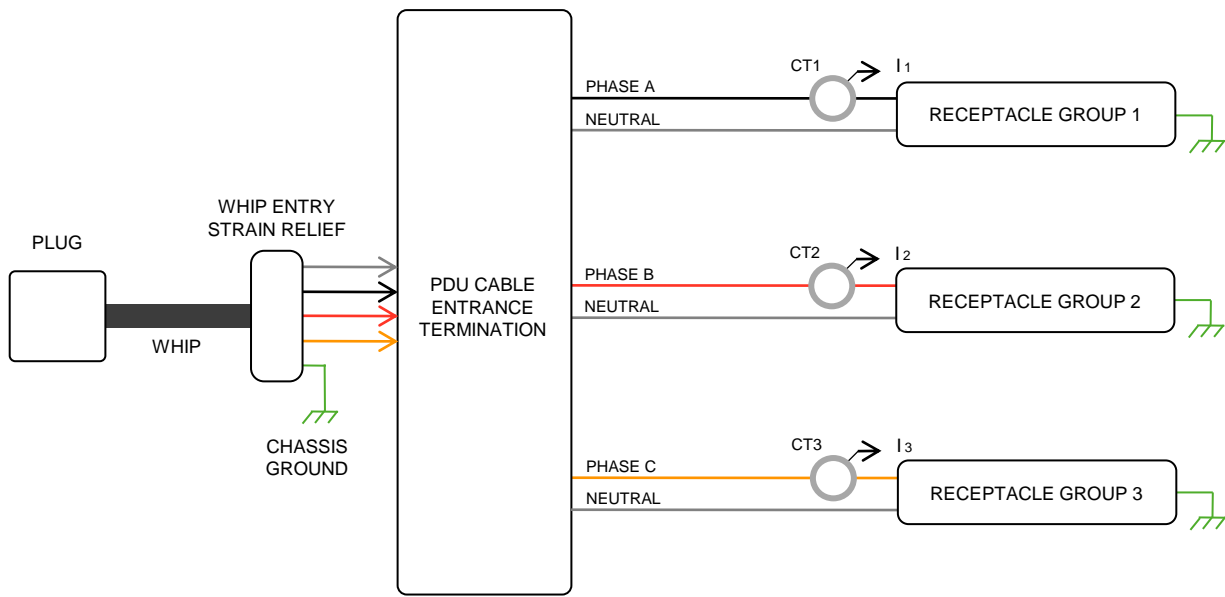

INPUT POWER:	
WHIP TYPE	12GA 5-WIRE SOOW
VOLTAGE	240/415V WYE 3PH
FREQUENCY	50/60 HZ
RATED AMPS	20A
MAX CONT. AMPS	16A
OUTPUT POWER:	
GROUP 1	PH A-N, 16A MAX CONT.
GROUP 2	PH B-N, 16A MAX CONT.
GROUP 3	PH C-N, 16A MAX CONT.

MADE AND ROBOTICALLY SOLDERED IN THE USA

GREAT LAKES

CUSTOMER SIGNATURE:	DATE:	UNLESS OTHERWISE SPECIFIED, ALL DIMENSIONS ARE IN MM AND TOLERANCES ARE: X = +/- 0.5 .X = +/- 0.25 .XX = +/- 0.13 X = +/- 0.5*	Great Lakes Data Racks and Cabinets	
*PRIOR TO MANUFACTURING, BUILD MODELS REQUIRE CUSTOMER SIGN-OFF. BY SIGNING, CUSTOMER AGREES THAT THIS ORDER IS NON-CANCELABLE AND NON-RETURNABLE.			TITLE: RACK PDU SPECIFICATION	
		DRAWING NUMBER: SP-GL8725		SHEET: 2 OF 2

THIS SPECIFICATION AND ITS CONTENTS ARE THE PROPERTY OF GREAT LAKES DATA RACKS AND CABINETS AND SHALL NOT BE COPIED OR REPRODUCED FOR ANY PURPOSES OTHER THAN APPLICATION OF PRODUCT MANUFACTURED BY GREAT LAKES. THIS DRAWING IS SUBJECT TO CHANGE WITHOUT NOTICE.