

REVISION HISTORY			
REV	DESCRIPTION	DATE	APPROVED
0	ECO-06860	5/13/2016	VL
1	ECO-06962	9/26/2016	VL

Bill of Material						
ITEM	PART NUMBER	STOCK #	QTY	DESCRIPTION	FILE NAME	Rev
1	I025961		1	70"H HINGED COVER VERTICAL CABLE MANAGER, WELDMENT	I025961.iam	1
2	1745A15	H19-209	2	Surface Mount Magnetic Catch 9 lbs. of Pull Power, 1-5/8" x 11/16" x 1/8"	1745A15.ipt	
3		H01-038	4	Screw, #6-32 x 1/4" undercut flat head phillips, black	H01-038.ipt	
4	CM47		5	4"DEEP x 7 RMU PLASTIC FINGER CABLE MANAGEMENT	I013299.ipt	3
5	I026012		1	4"DEEP x 4 RMU PLASTIC FINGER CABLE MANAGEMENT	I026012.ipt	0
6		H01-078	22	SCREW, 10-32x1/2" PH PAN TYPE 23 BLACK ZINC RoHS	H01-078.ipt	-
7		H19-242	1	EXTRUDED ALUMINUM OPEN-ENDED PULL HANDLE (McMaster PN.11625A11 OR EQUIV.)	H19-242.ipt	-
8		H01-265	7	#10-32 x 3/4"L PAN HEAD PHIL MS, BLACK	H01-265.ipt	-
9		H02-001	7	#10-32 KEPS NUT, ZINC RoHS (10/32NUT)	H02-001.iam	-

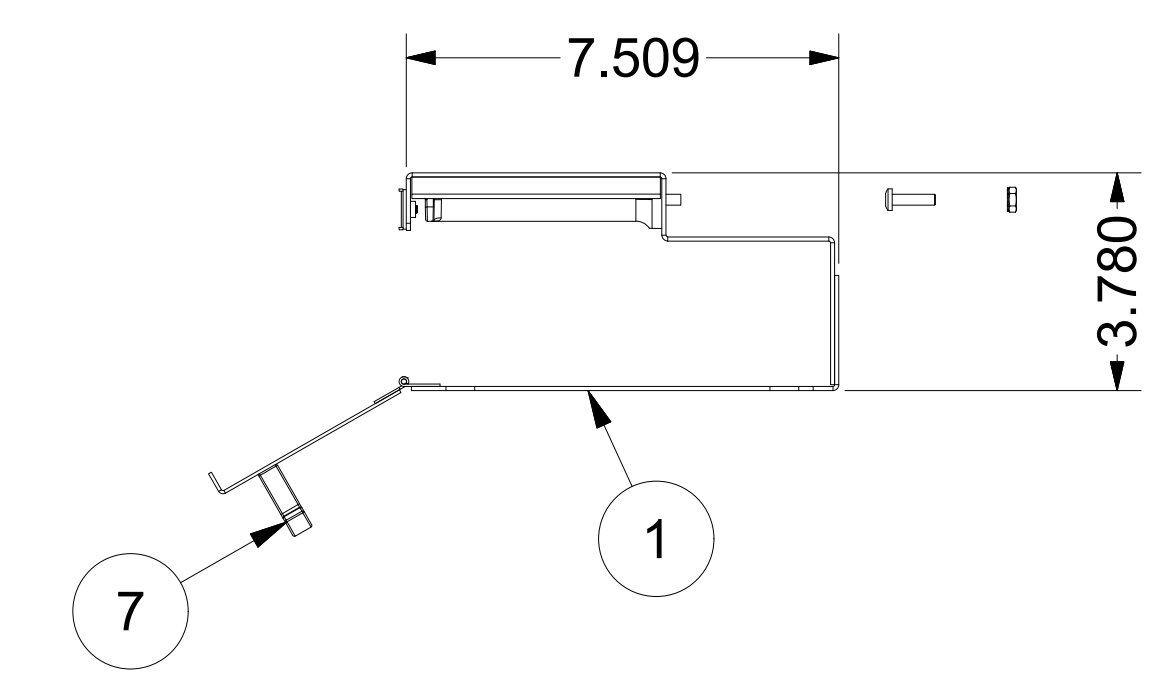
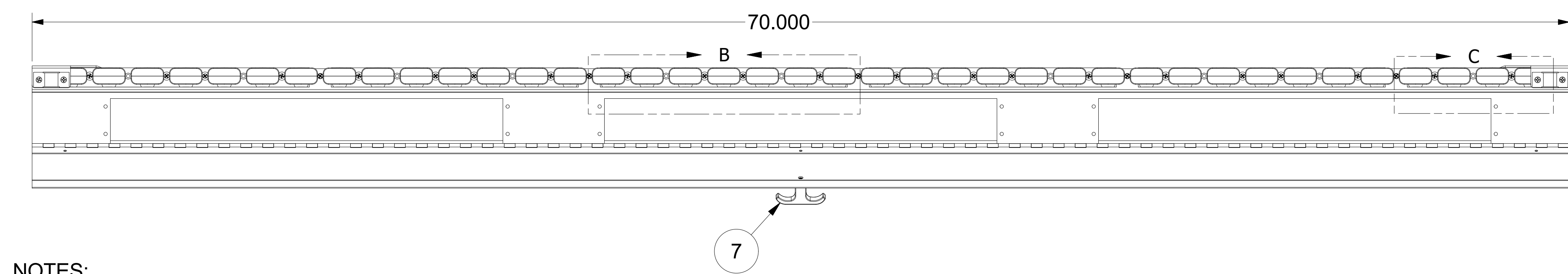
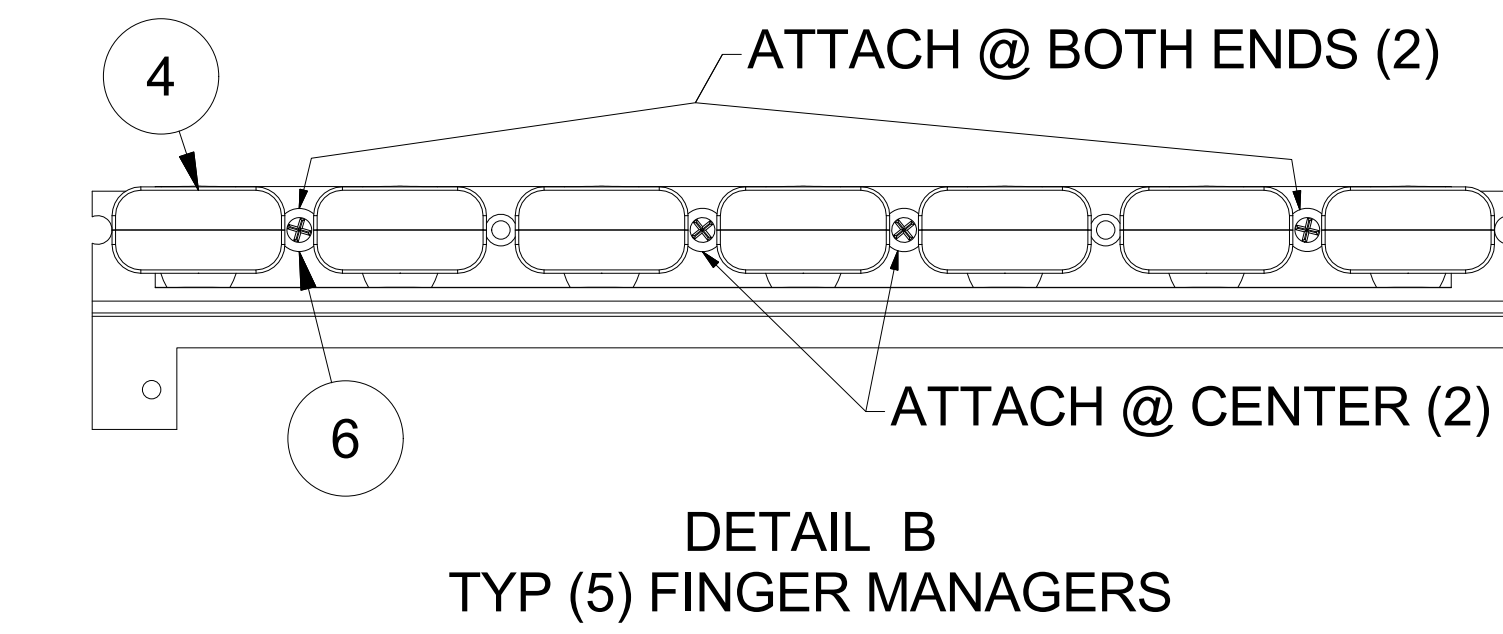
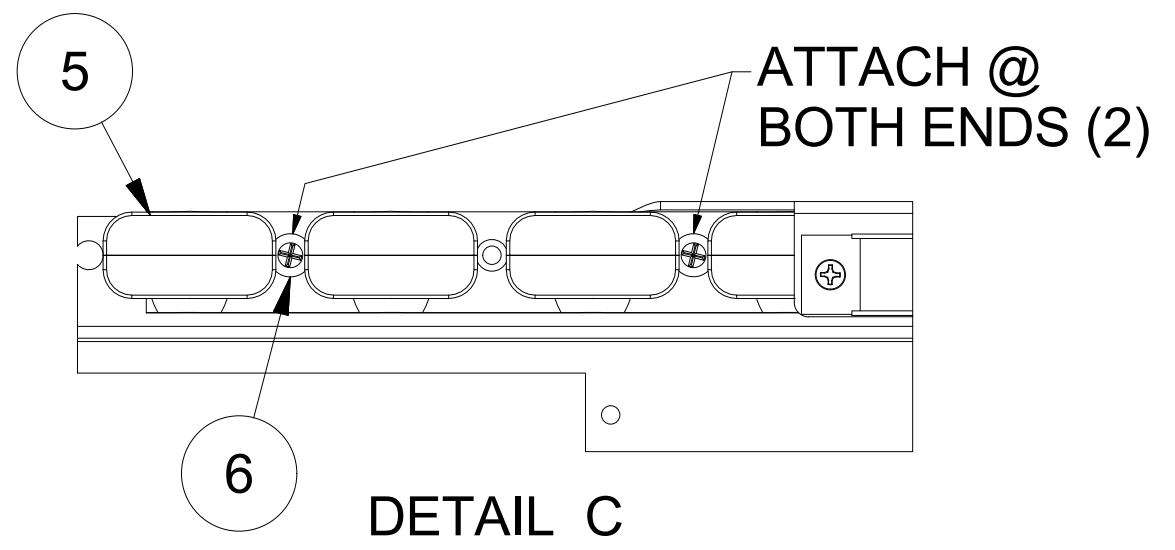
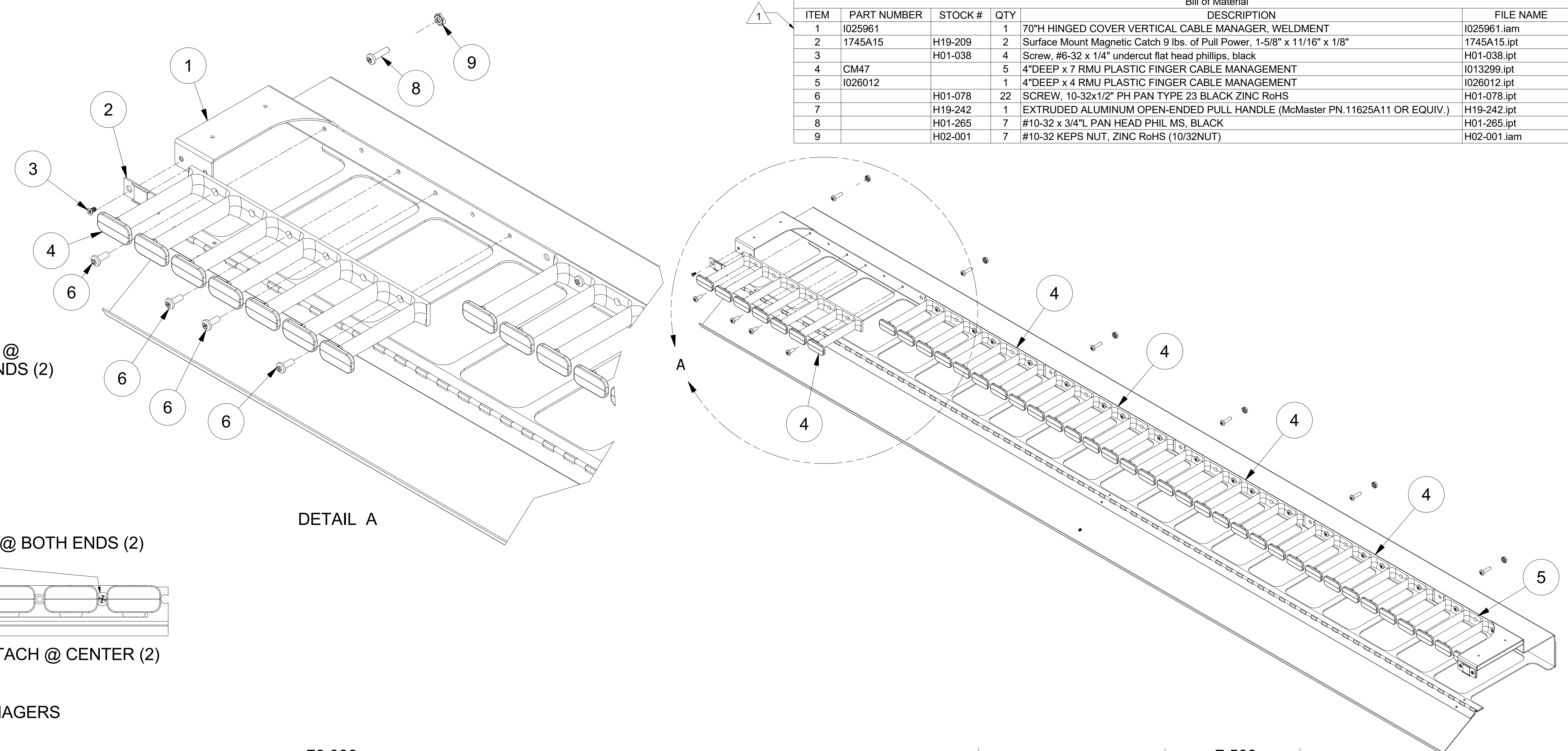

- NOTES:**
- SEE PURCHASE ORDER, SPECIAL INSTRUCTIONS MAY APPLY.
 - INSTALL THE CM47 PLASTIC FINGERS ONTO THE HINGED COVER WELDMENT USING SCREWS INTO THE TAPPED HOLES.
(4) SCREWS PER CM47 AS SHOWN. 4-RMU PLASTIC FINGER (I026012) TO BE SECURED W/ (2) SCREWS
 - CREATE HARDWARE PACK FOR THE (7) HEX NUTS AND (7) SCREWS (ITEMS# 8 & 9), WIRE TIE PACK TO UNIT.
 - INSTALL MAGNETIC CATCH AND PULL HANDLE WITH HARDWARE AS SHOWN.
 - SHIP FLAT ON PALLET. IF NOT INSTRUCTED TO INSTALL ON FRAME FROM P.O.

EST. WEIGHT: N/A	INTERPRET DRAWING PER ASME Y14.5M-1994	NOTICE: Use of this document is subject to a confidentiality and nondisclosure agreement with Great Lakes Case & Cabinet Co., Inc. (GLCC) and may not be reproduced, disclosed or utilized in whole or in part without prior written authorization from GLCC.	PART NUMBER: VCM84KX100	TITLE: 70"H HINGED COVER VERTICAL CABLE MANAGER FOR 84"H 'E/' 'ES' ENCLOSURES, VENDOR LEVEL
	DIMENSIONAL LIMITS APPLY AFTER APPLICATION OF FINISH		QTY PER UNIT: 1	GREAT LAKES CASE & CABINET CO., INC. P.O. BOX 551 EDINBORO, PA 16412 PHONE (814) 734-7303 FAX (814) 734-3907 E-MAIL glcc@greatcabinets.com
THIRD ANGLE PROJECTION	DRAWING NOT TO SCALE		MATERIAL TYPE: SEE DETAILS	DWG NO: I025960
	TOLERANCE UNLESS OTHERWISE NOTED: ANGULAR +/- 1' .XXXX +/- .010 .XXX +/- .015 .XX +/- .030 .X FOR REF. ONLY		MATERIAL GAUGE: SEE DETAILS	REV: 1
	UNLESS OTHERWISE SPECIFIED ALL DIMENSIONS ARE IN INCHES		DRAWN: VL	SHEET: 1 OF 1
			CHECKED & APP. WSS	
			DATE: 5/12/2016	
			DATE: 5/24/2016	

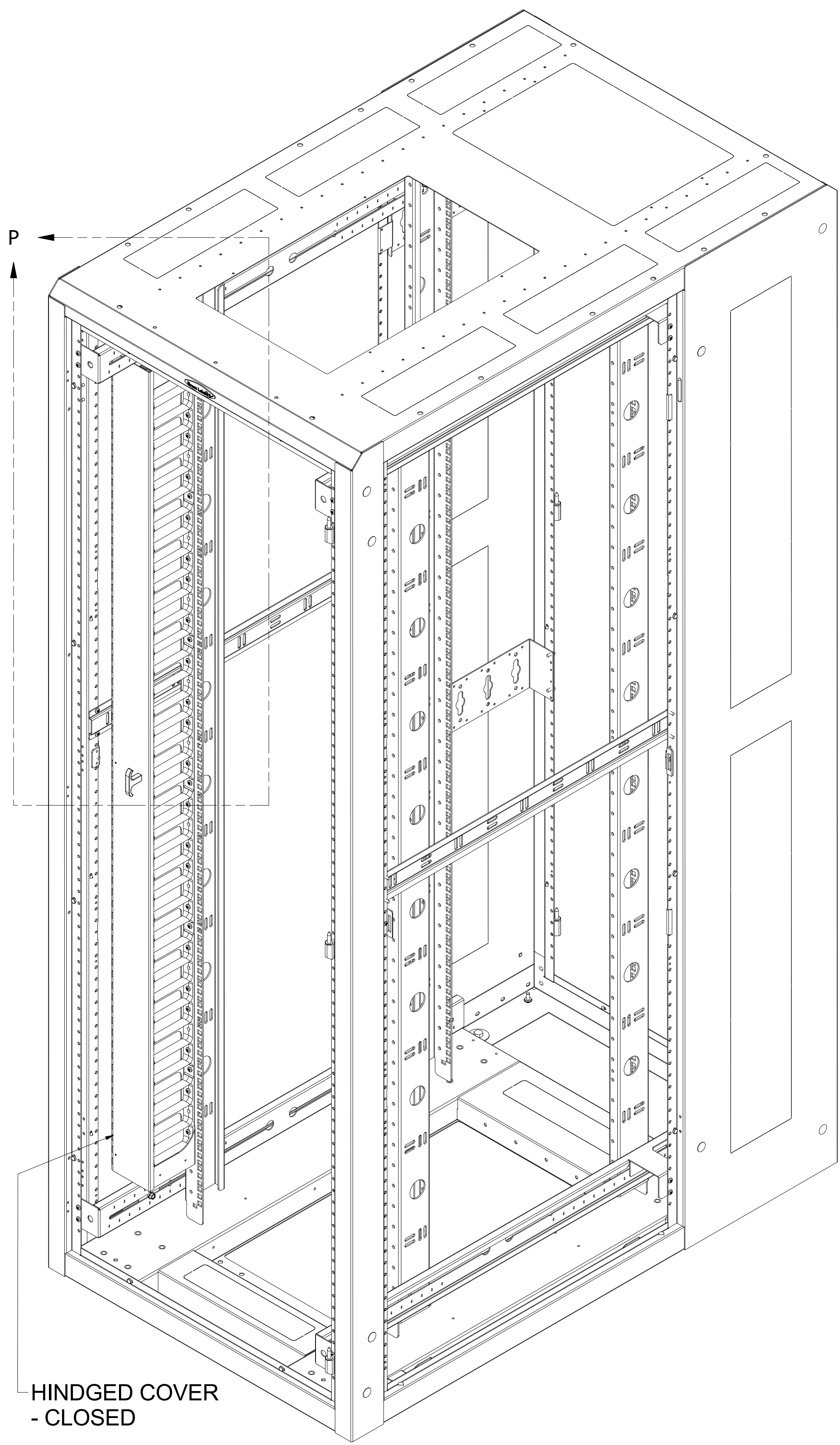

HINDGED COVER
- CLOSED

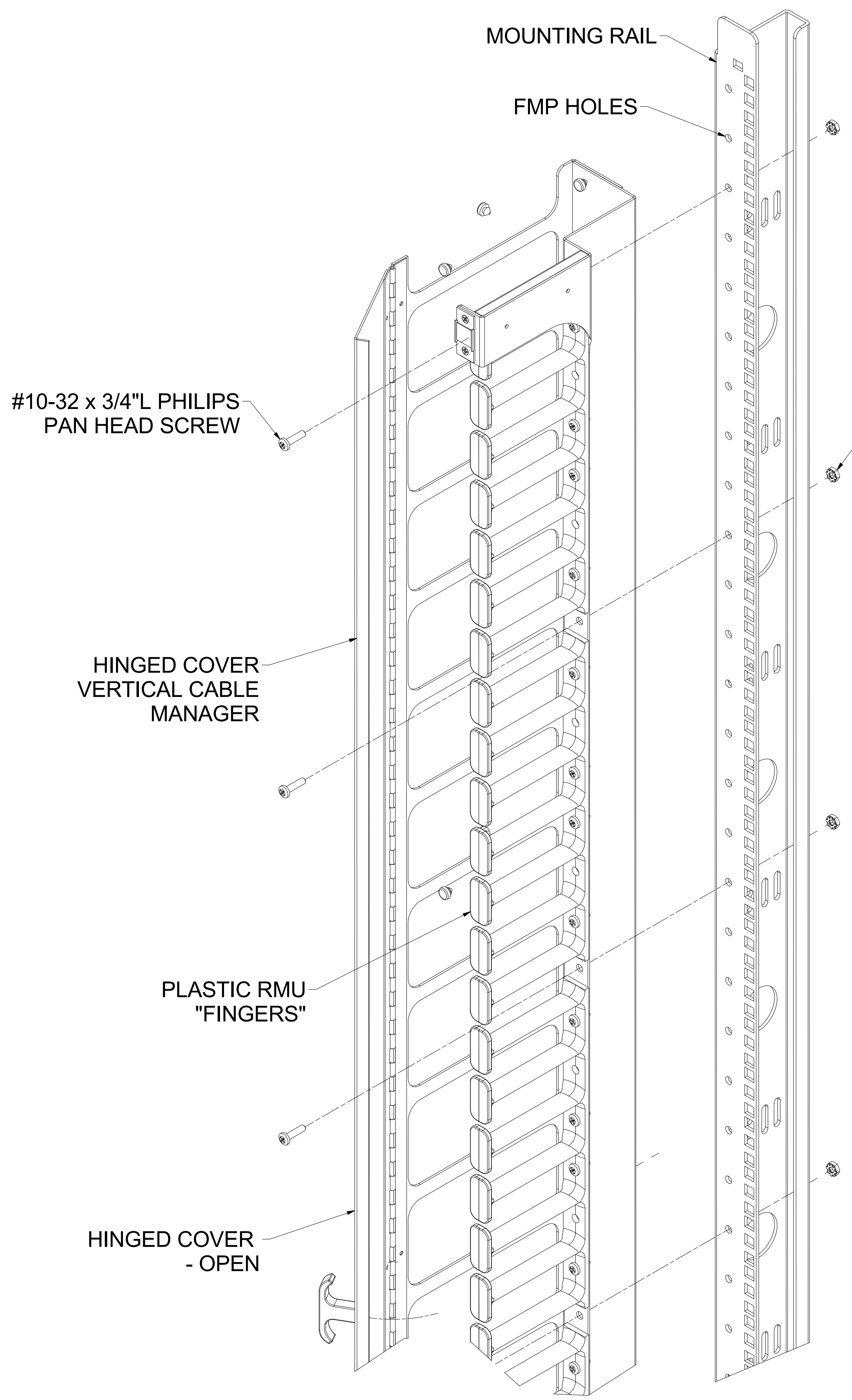

#10-32 x 3/4" L PHILIPS
PAN HEAD SCREW

HINGED COVER
VERTICAL CABLE
MANAGER

PLASTIC RMU
"FINGERS"

HINGED COVER
- OPEN

MOUNTING RAIL

FMP HOLES

#10-32 KEPS NUT

DETAIL N

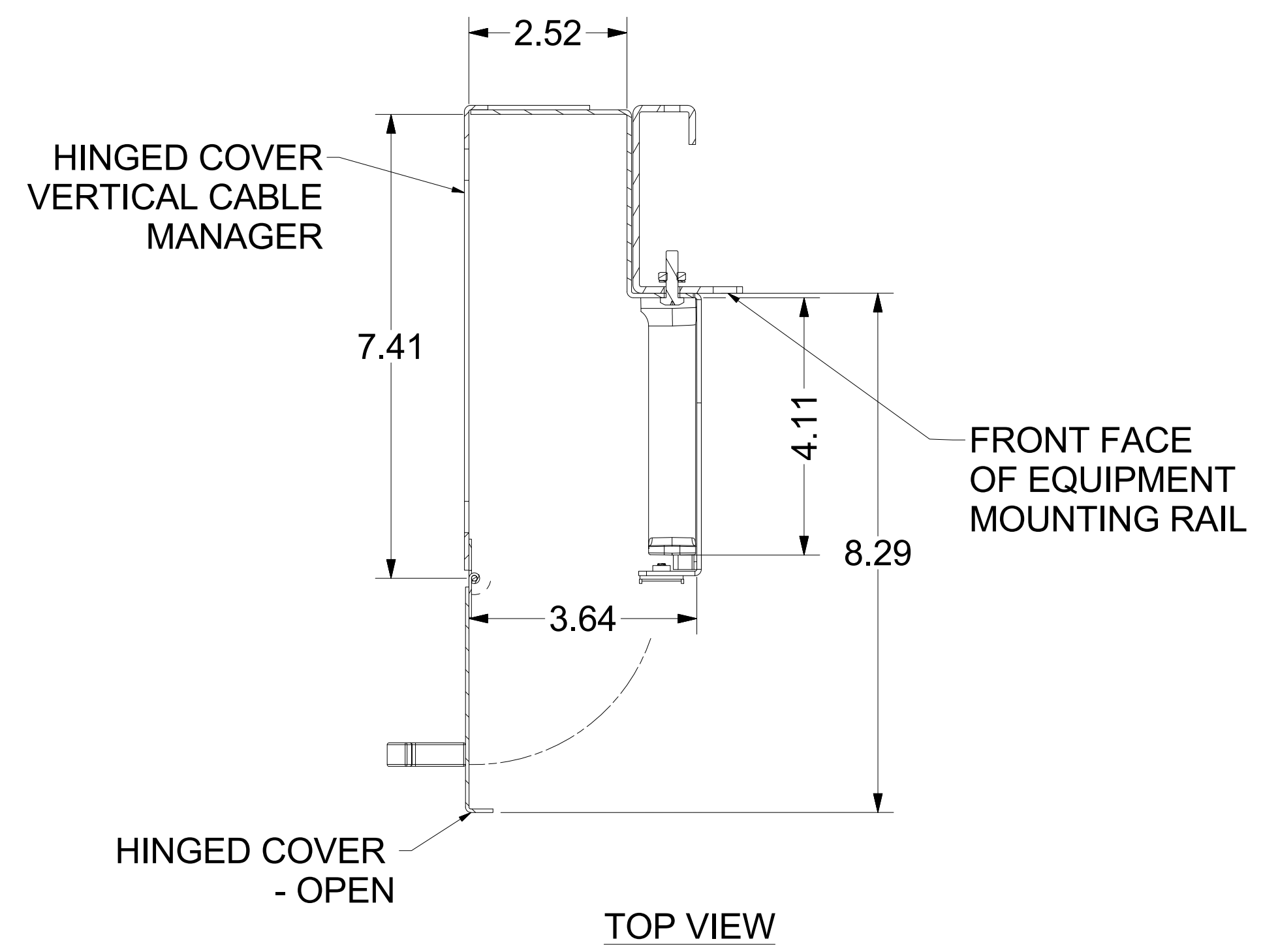

TOP VIEW

HINGED COVER VERTICAL CABLE MANAGER

The Hinged Vertical Cable Manager (VCMK) mounts to the Flexible Mounting Profile (FMP) of enclosure rails between plastic RMU "fingers". The VCMK to be secured to mounting rail with #10-32 x 3/4"lg. screws and #10-32 keps nuts (hardware provided). Reversible VCMK can be installed on left, right, front or rear rails. If installed on front rails, the rails must be recessed 9-1/8" for proper hinged cover clearance.

Available Hinged Cover Vertical Cable Management Kits include:
 VCM-79K Vertical Cable Manager for 790ES-30 enclosures
 VCM-84K Vertical Cable Manager for 840E-29 and 840ES-30 enclosures
 VCM-91K Vertical Cable Manager for 910ES-30 enclosures

REVISION HISTORY		
REV	DATE	APPROVED
0	9/27/17	CND

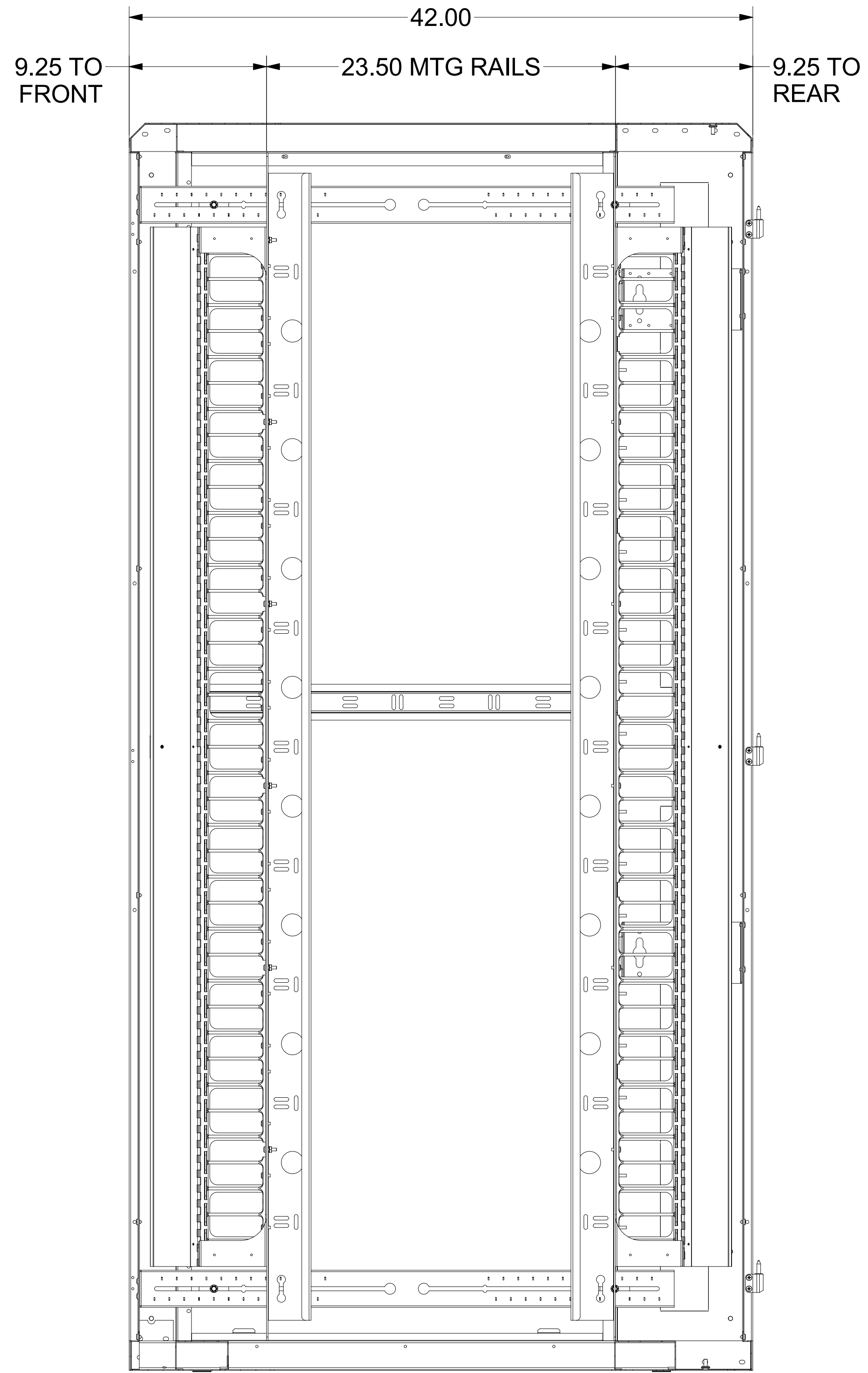
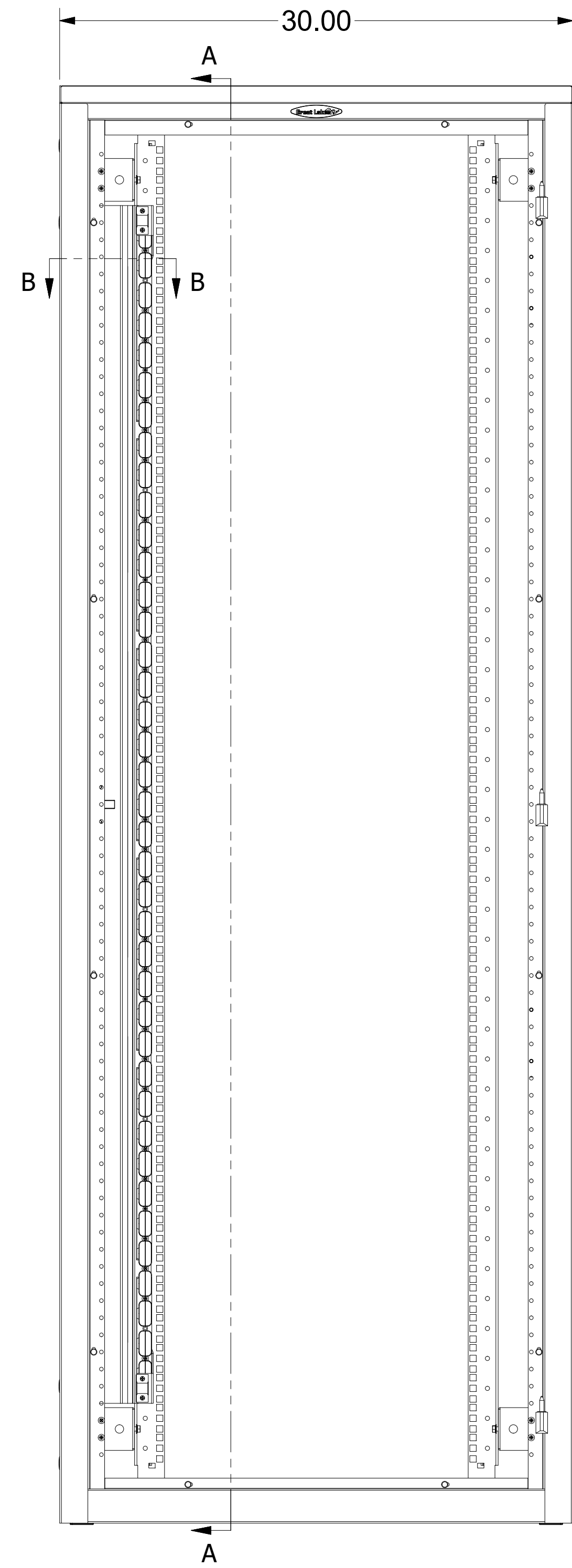

SECTION A-A

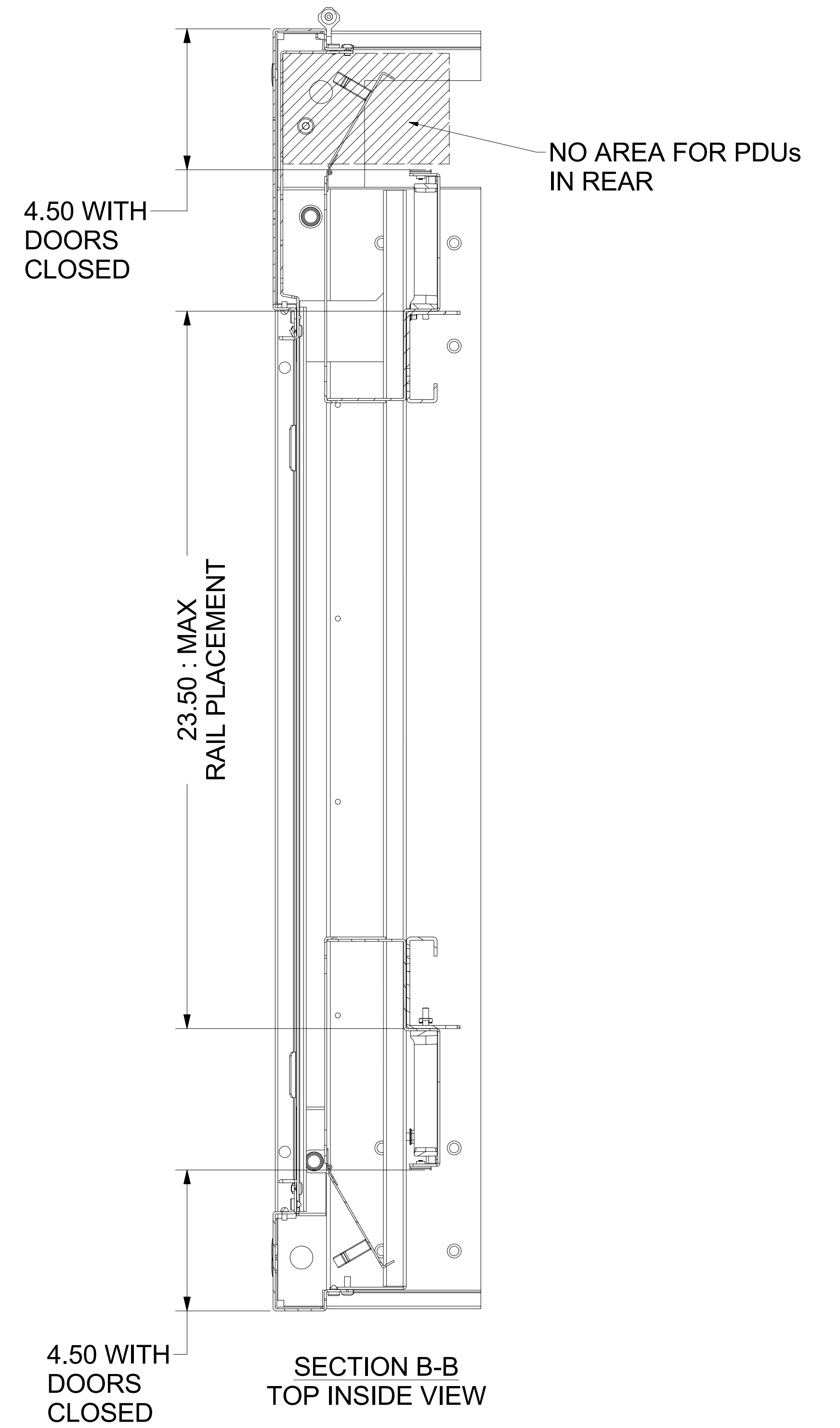

42"D ES, VCM84K ON FRONT AND REAR

EST. WEIGHT :
N/A

THIRD ANGLE PROJECTION

INTERPRET DRAWING PER ASME Y14.5M-1994
DIMENSIONAL LIMITS APPLY AFTER APPLICATION OF FINISH
DRAWING NOT TO SCALE
TOLERANCE UNLESS OTHERWISE NOTED:
ANGULAR +/- 1'
.XXXX +/- .010
.XXX +/- .015
.XX +/- .030
.X FOR REF. ONLY
UNLESS OTHERWISE SPECIFIED ALL DIMENSIONS ARE IN INCHES

NOTICE:
Use of this document is subject to a confidentiality and nondisclosure agreement with Great Lakes Case & Cabinet Co., Inc. (GLCC) and may not be reproduced, disclosed or utilized in whole or in part without prior written authorization from GLCC.

PART NUMBER:
SEE CHART
MATERIAL TYPE:
MATERIAL GAUGE:
FINISH:
DRAWN VL
CHECKED & APP. VL

TITLE
SEE CHART
GREAT LAKES CASE & CABINET CO., INC.
P.O. BOX 551 EDINBORO, PA 16412
PHONE (814) 734-7303 FAX (814) 734-3907
E-MAIL glcc@greatcabinets.com
DWG NO: VCM84K INSTALLED
REV: 00
DATE: 9/27/2017
DATE: 9/27/2017
SHEET: 2 OF 7

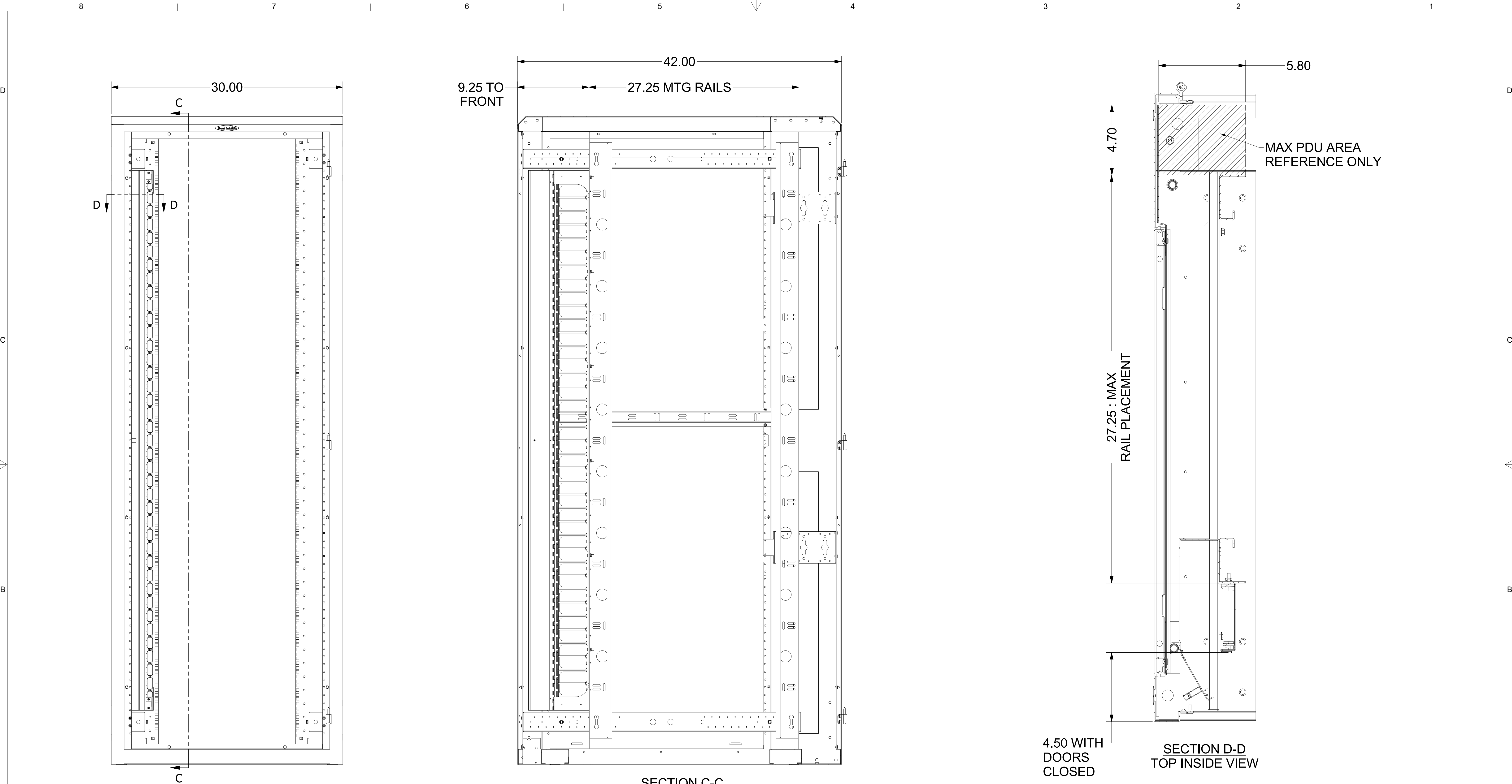

42"D ES, VCM84K ON FRONT ONLY

EST. WEIGHT :
N/A

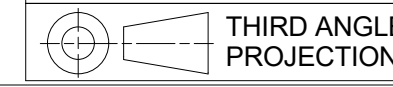

INTERPRET DRAWING PER ASME Y14.5M-1994
 DIMENSIONAL LIMITS APPLY
 AFTER APPLICATION OF FINISH
 DRAWING NOT TO SCALE
 TOLERANCE UNLESS OTHERWISE NOTED:
 ANGULAR +/- .1°
 .XXXX +/- .010
 .XXX +/- .015
 .XX +/- .030
 .X FOR REF. ONLY
 UNLESS OTHERWISE SPECIFIED
 ALL DIMENSIONS ARE IN INCHES

NOTICE:
 Use of this document is subject to a confidentiality and nondisclosure agreement with Great Lakes Case & Cabinet Co., Inc. (GLCC) and may not be reproduced, disclosed or utilized in whole or in part without prior written authorization from GLCC.

PART NUMBER:
SEE CHART
 MATERIAL TYPE:
 MATERIAL GAUGE:
 FINISH:
 DRAWN VL DATE 9/27/2017
 CHECKED & APP. DATE

TITLE
SEE CHART
GREAT LAKES CASE & CABINET CO., INC.
 P.O. BOX 551 EDINBORO, PA 16412
 PHONE (814) 734-7303 FAX (814) 734-3907
 E-MAIL glcc@greatcabinets.com
 DWG NO: **VCM84K INSTALLED** REV
 SHEET: 3 OF 7

8 7 6 5 4 3 2 1

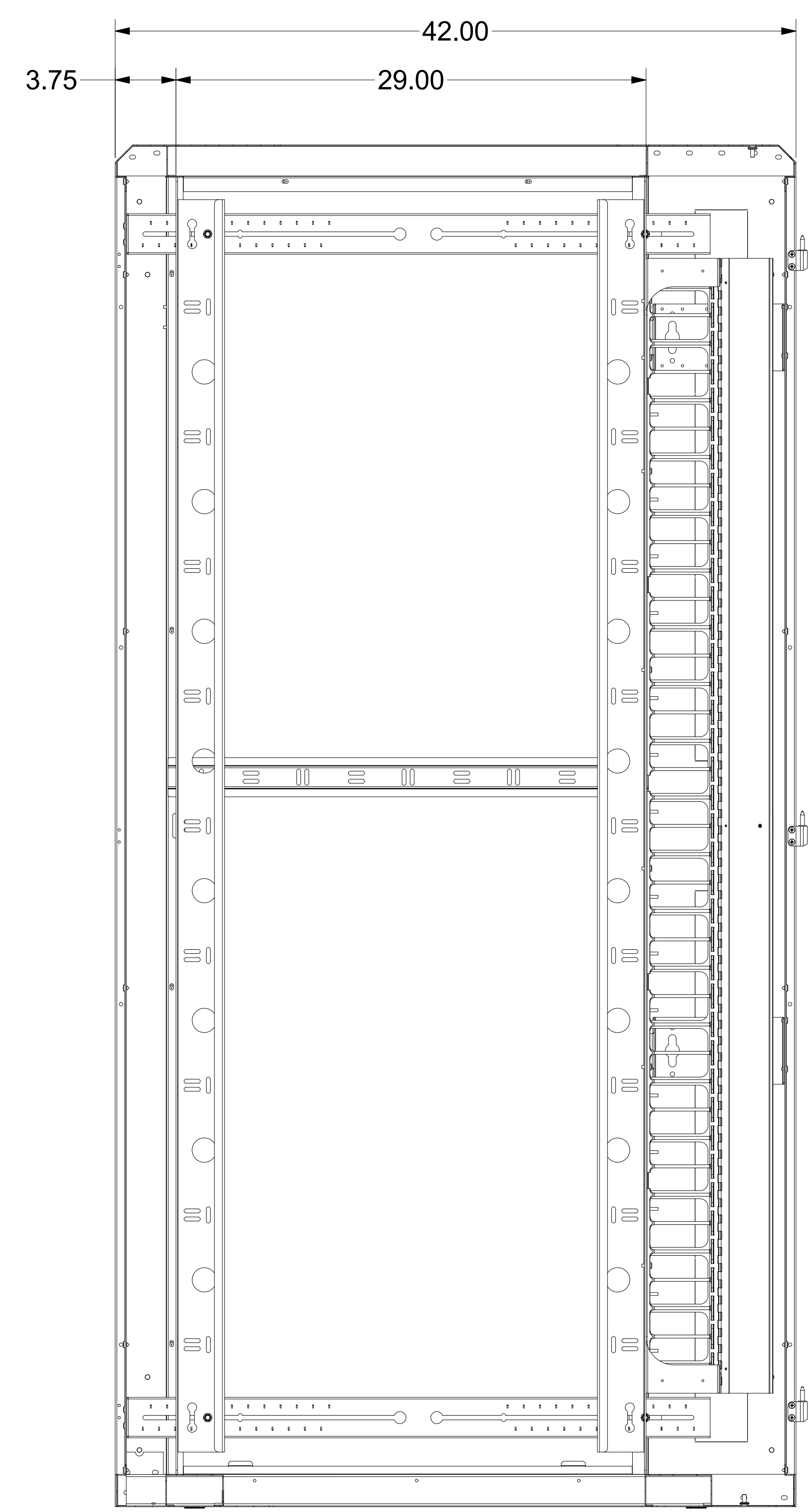
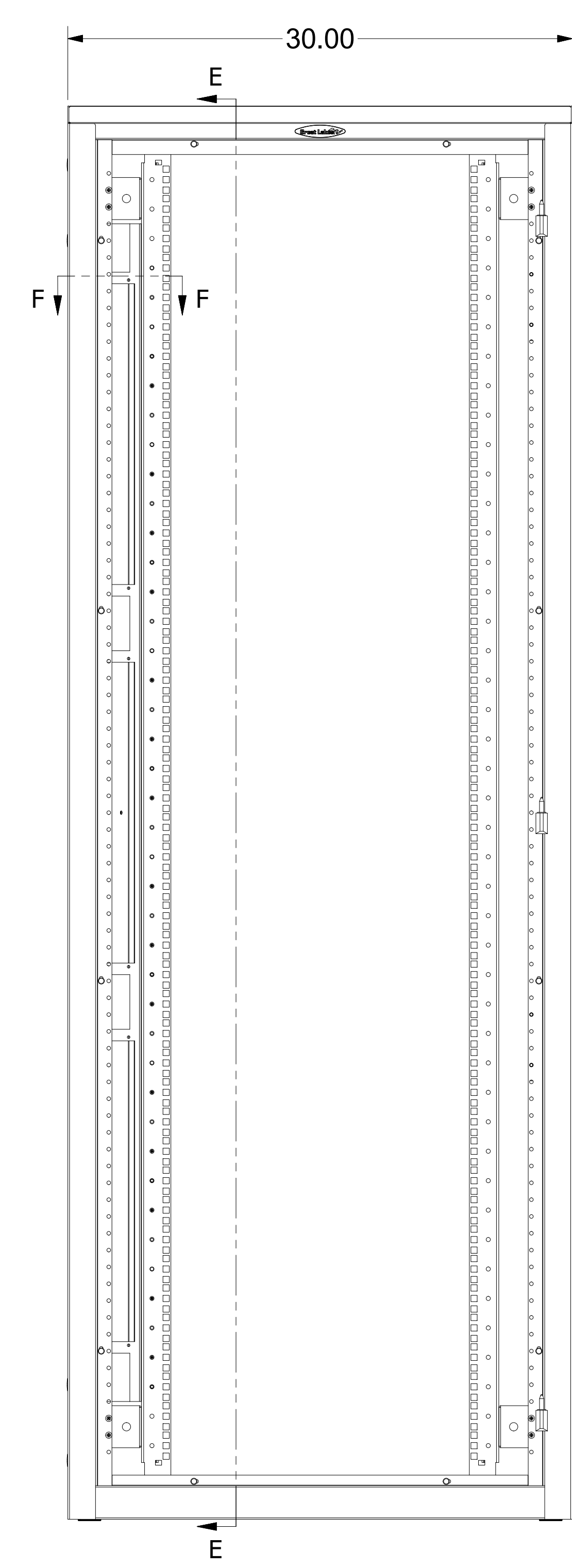

SECTION E-E

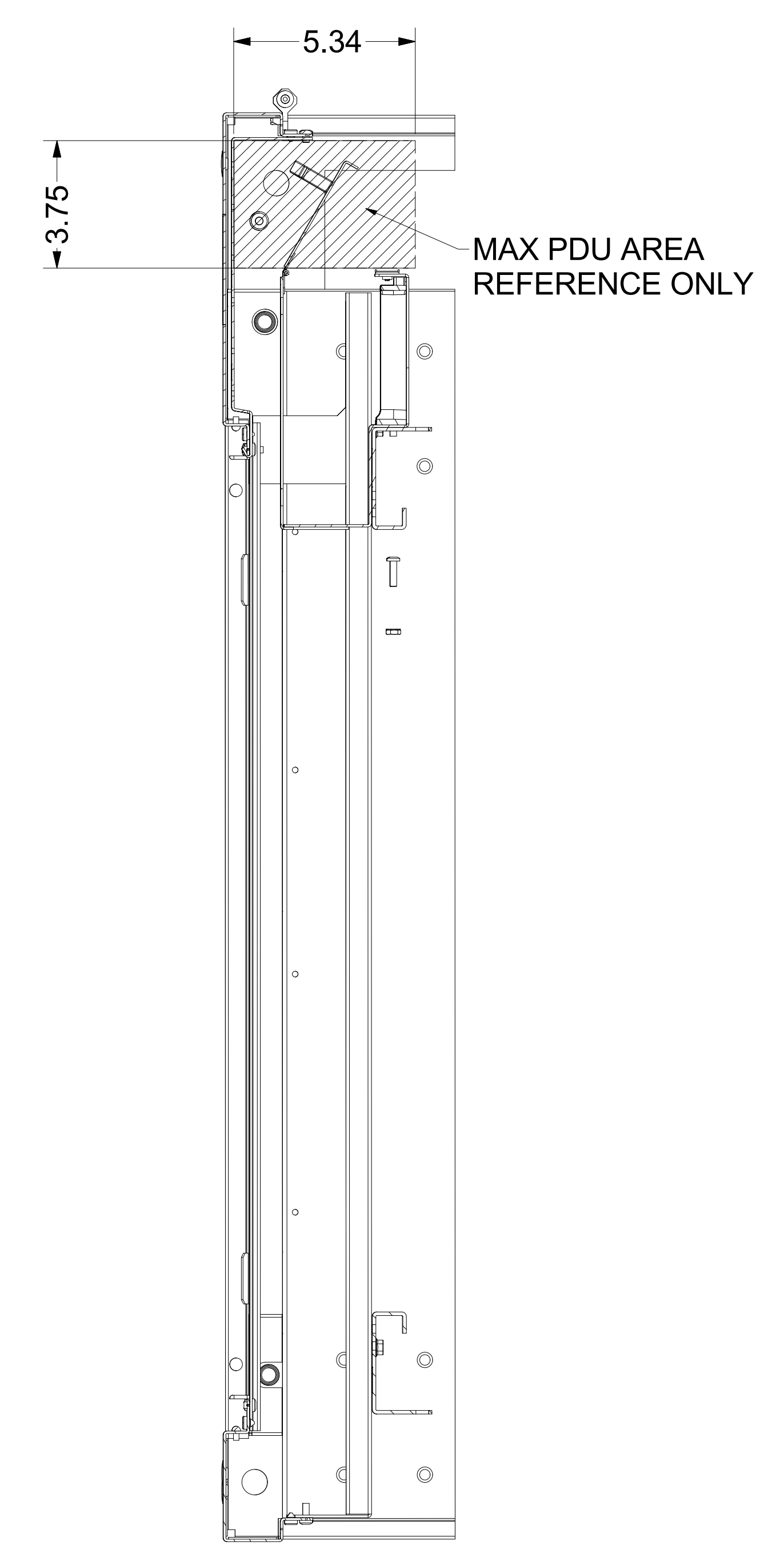

SECTION F-F
TOP INSIDE VIEW

42"D ES, VCM84K ON REAR

EST. WEIGHT :
N/A

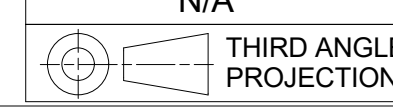

INTERPRET DRAWING PER ASME Y14.5M-1994
DIMENSIONAL LIMITS APPLY
AFTER APPLICATION OF FINISH
DRAWING NOT TO SCALE
TOLERANCE UNLESS OTHERWISE NOTED:
ANGULAR +/- 1°
.XXXX +/- .010
.XXX +/- .015
.XX +/- .030
.X FOR REF. ONLY
UNLESS OTHERWISE SPECIFIED
ALL DIMENSIONS ARE IN INCHES

NOTICE:
Use of this document is subject to a confidentiality and nondisclosure agreement with Great Lakes Case & Cabinet Co., Inc. (GLCC) and may not be reproduced, disclosed or utilized in whole or in part without prior written authorization from GLCC.

PART NUMBER:
MATERIAL TYPE:
MATERIAL GAUGE:
FINISH:
DRAWN VL
CHECKED & APP. VL

TITLE
VCM84K 3042 REAR ONLY
SEE CHART
GREAT LAKES CASE & CABINET CO., INC.
P.O. BOX 551 EDINBORO, PA 16412
PHONE (814) 734-7303 FAX (814) 734-3907
E-MAIL glcc@greatcabinets.com
DWG NO:
VCM84K INSTALLED
REV
DATE
DATE
SHEET: 4 OF 7

8 7 6 5 4 3 2 1

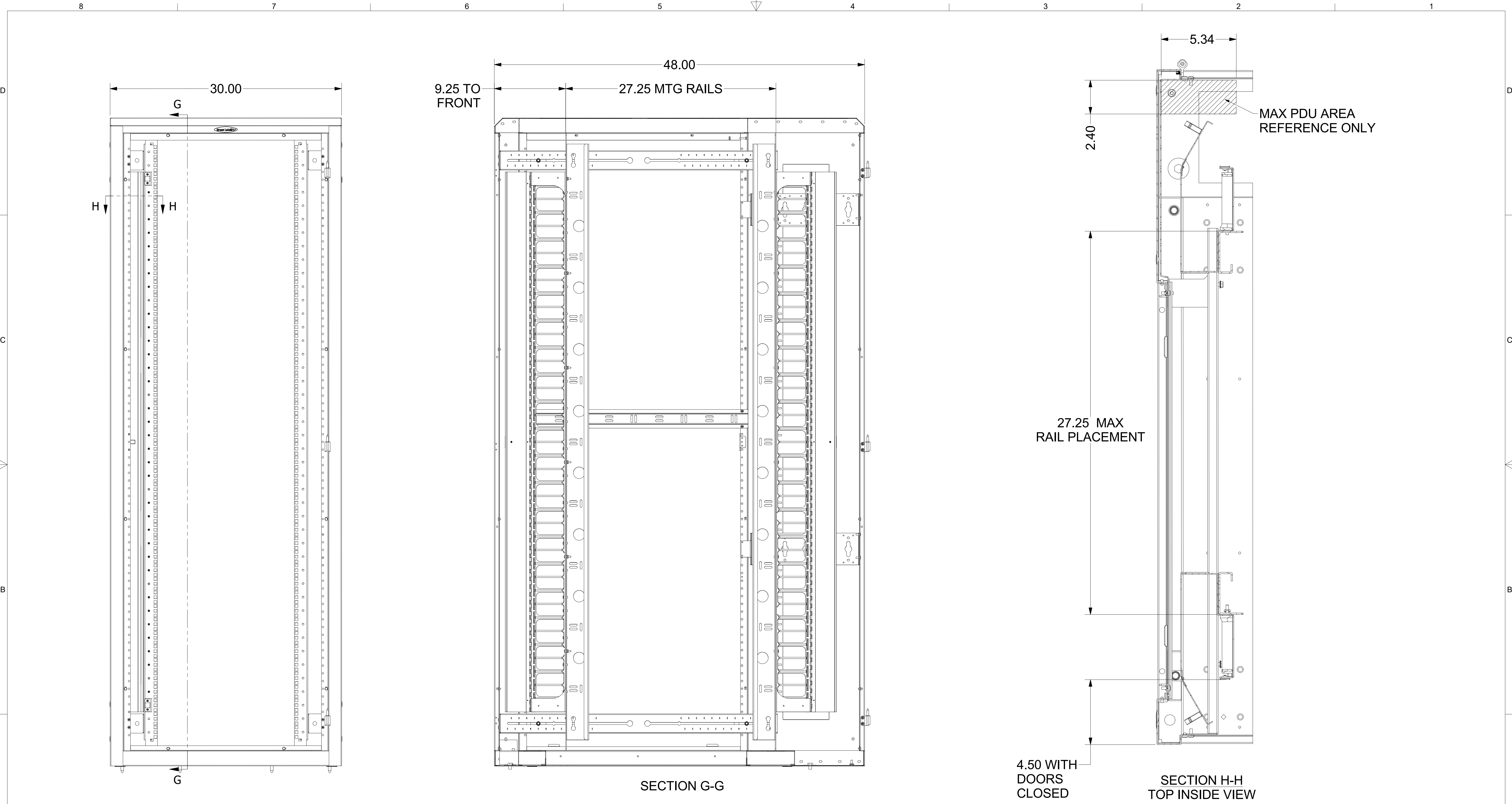

48"D ES, VCM84K ON FRONT AND REAR

EST. WEIGHT :
N/A

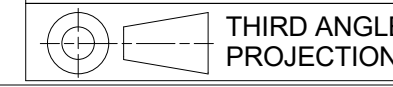

INTERPRET DRAWING PER ASME Y14.5M-1994
 DIMENSIONAL LIMITS APPLY
 AFTER APPLICATION OF FINISH
 DRAWING NOT TO SCALE
 TOLERANCE UNLESS OTHERWISE NOTED:
 ANGULAR +/- 1°
 .XXXX +/- .010
 .XXX +/- .015
 .XX +/- .030
 .X FOR REF. ONLY
 UNLESS OTHERWISE SPECIFIED
 ALL DIMENSIONS ARE IN INCHES

NOTICE:
 Use of this document is subject to a confidentiality and nondisclosure agreement with Great Lakes Case & Cabinet Co., Inc. (GLCC) and may not be reproduced, disclosed or utilized in whole or in part without prior written authorization from GLCC.

PART NUMBER:
SEE CHART
 MATERIAL TYPE:
 MATERIAL GAUGE:
 FINISH:
 DRAWN VL DATE 9/27/2017
 CHECKED & APP. DATE

TITLE
SEE CHART
 GREAT LAKES CASE & CABINET CO., INC.
 P.O. BOX 551 EDINBORO, PA 16412
 PHONE (814) 734-7303 FAX (814) 734-3907
 E-MAIL glcc@greatcabinets.com
 DWG NO: **VCM84K INSTALLED** REV
 SHEET: 5 OF 7

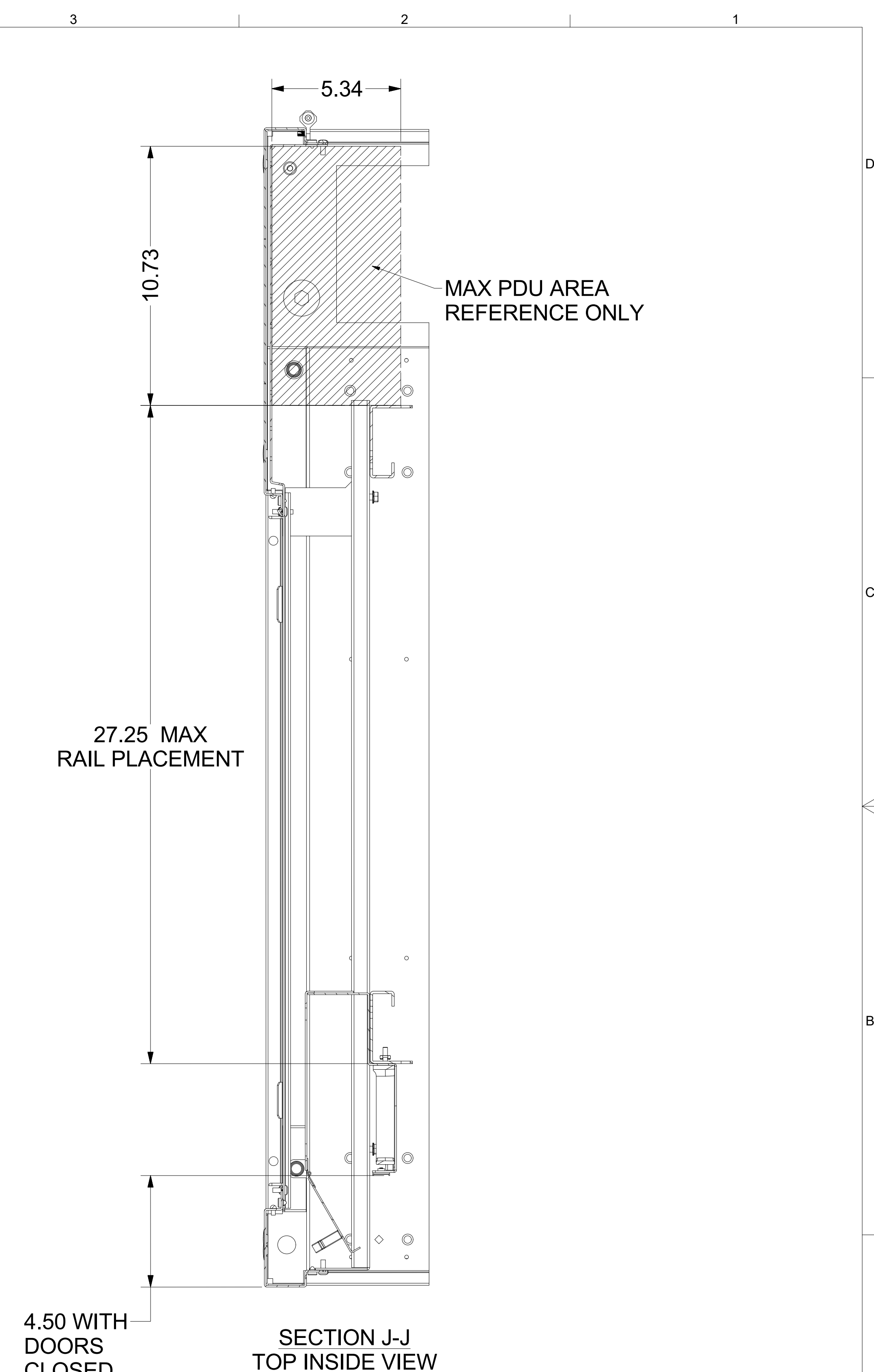
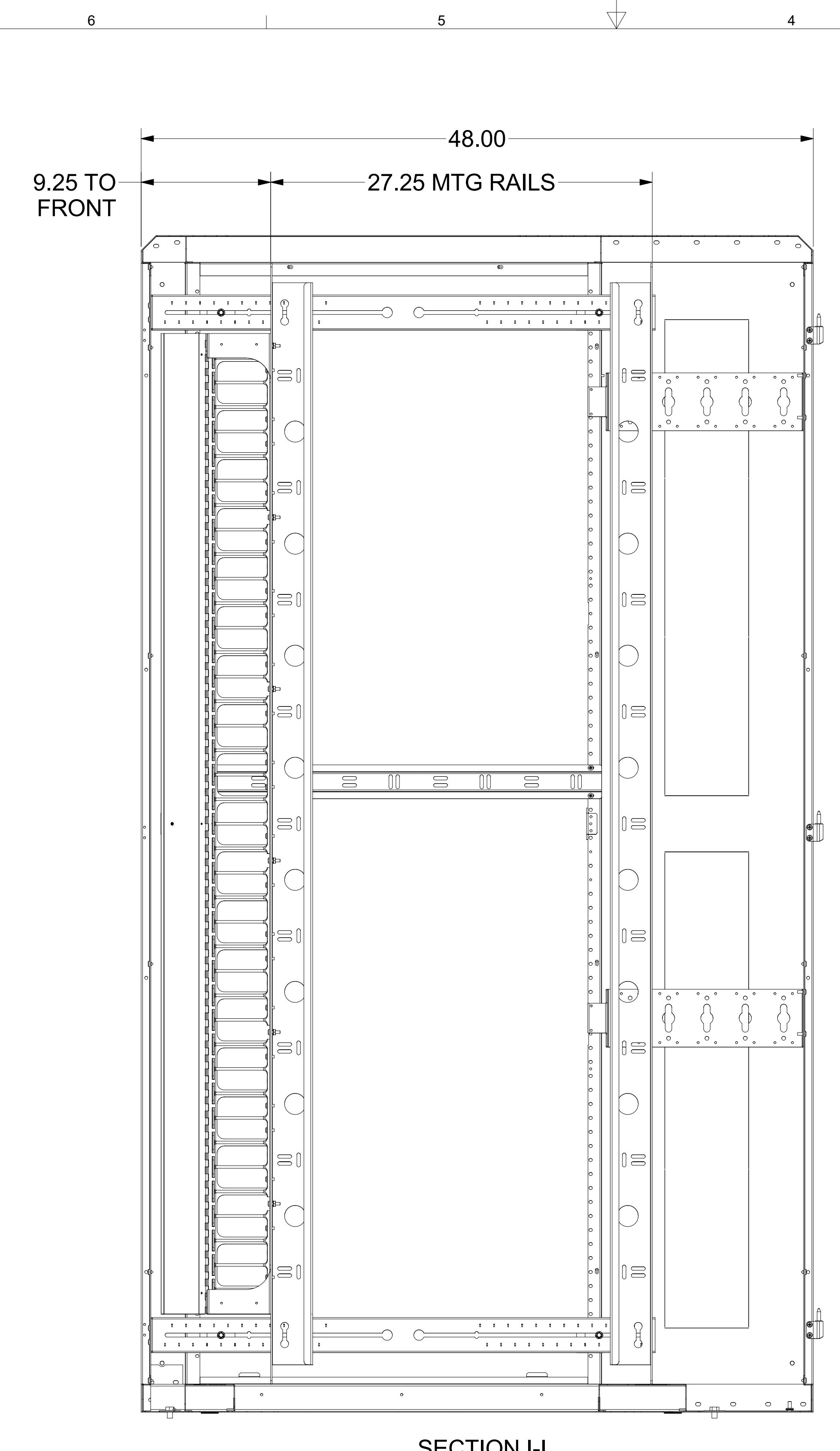
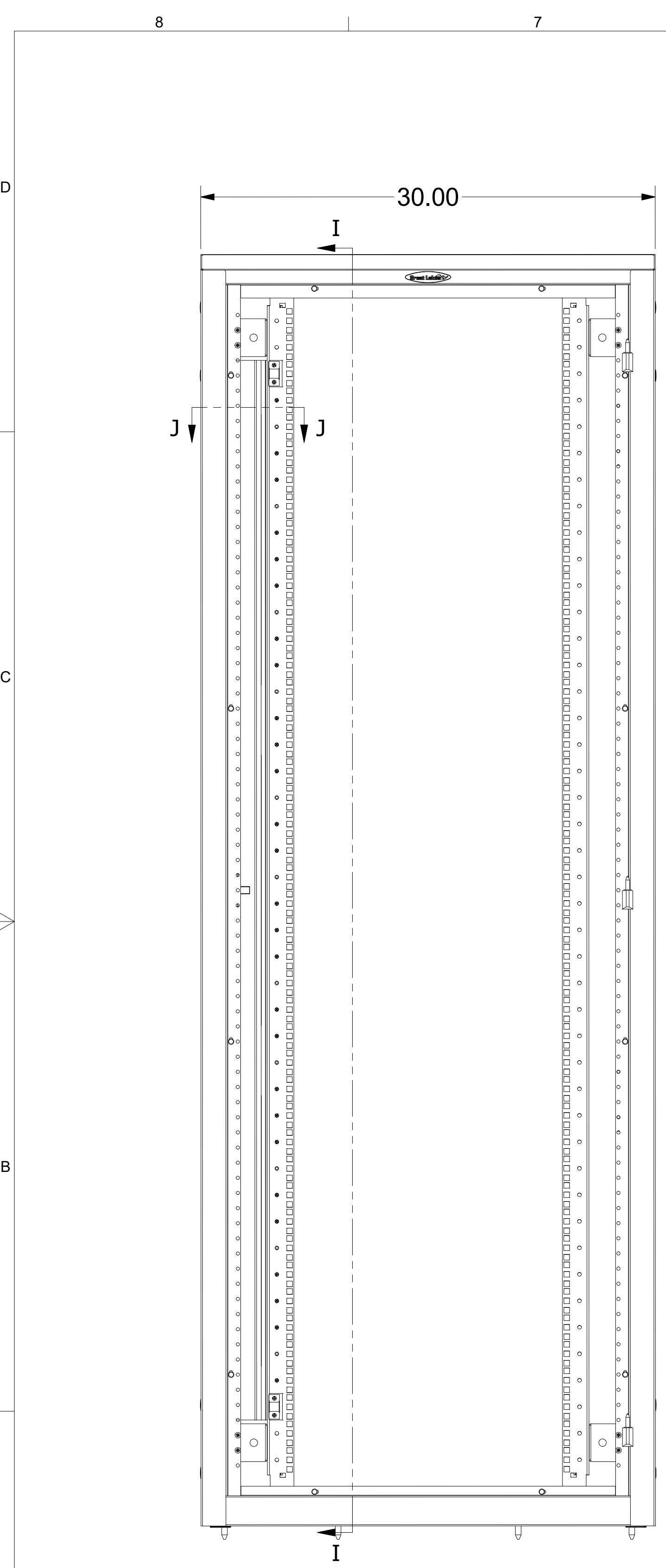

48"D ES, VCM84K ON FRONT ONLY

EST. WEIGHT :
N/A

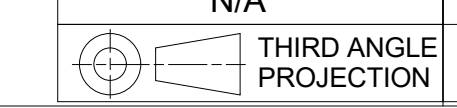

INTERPRET DRAWING PER ASME Y14.5M-1994
DIMENSIONAL LIMITS APPLY
AFTER APPLICATION OF FINISH
DRAWING NOT TO SCALE
TOLERANCE UNLESS OTHERWISE NOTED:
ANGULAR +/- 1°
.XXXX +/- .010
.XXX +/- .015
.XX +/- .030
.X FOR REF. ONLY
UNLESS OTHERWISE SPECIFIED
ALL DIMENSIONS ARE IN INCHES

NOTICE:
Use of this document is subject to a confidentiality and nondisclosure agreement with Great Lakes Case & Cabinet Co., Inc. (GLCC) and may not be reproduced, disclosed or utilized in whole or in part without prior written authorization from GLCC.

PART NUMBER:
SEE CHART
MATERIAL TYPE:
MATERIAL GAUGE:
FINISH:
DRAWN: VL
CHECKED & APP.: VL
DATE: 9/27/2017

TITLE
SEE CHART
GREAT LAKES CASE & CABINET CO., INC.
P.O. BOX 551 EDINBORO, PA 16412
PHONE (814) 734-7303 FAX (814) 734-3907
E-MAIL glcc@greatcabinets.com
DWG NO: **VCM84K INSTALLED**
REV: **SEE CHART**
SHEET: 6 OF 7

8 7 6 5 4 3 2 1

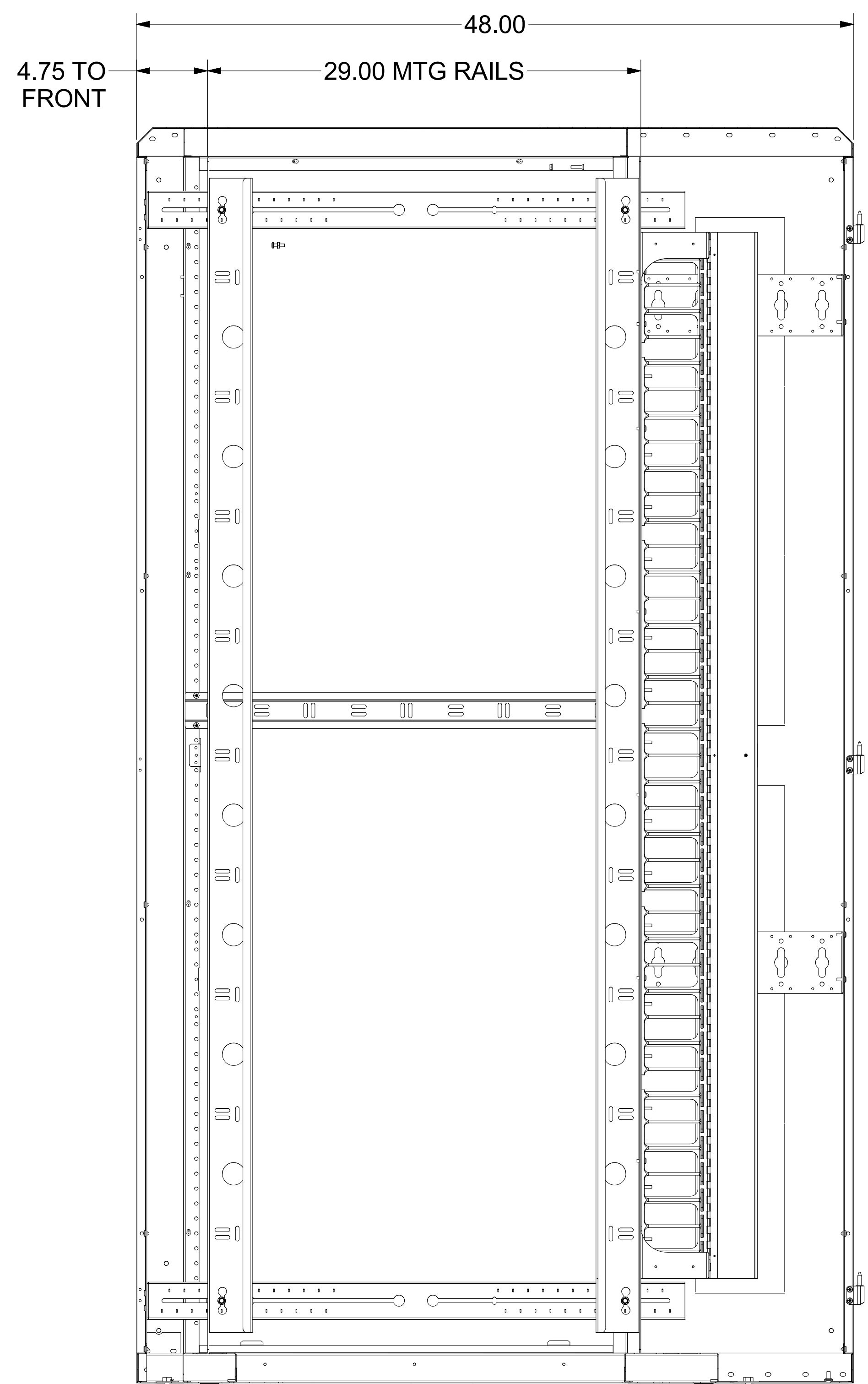
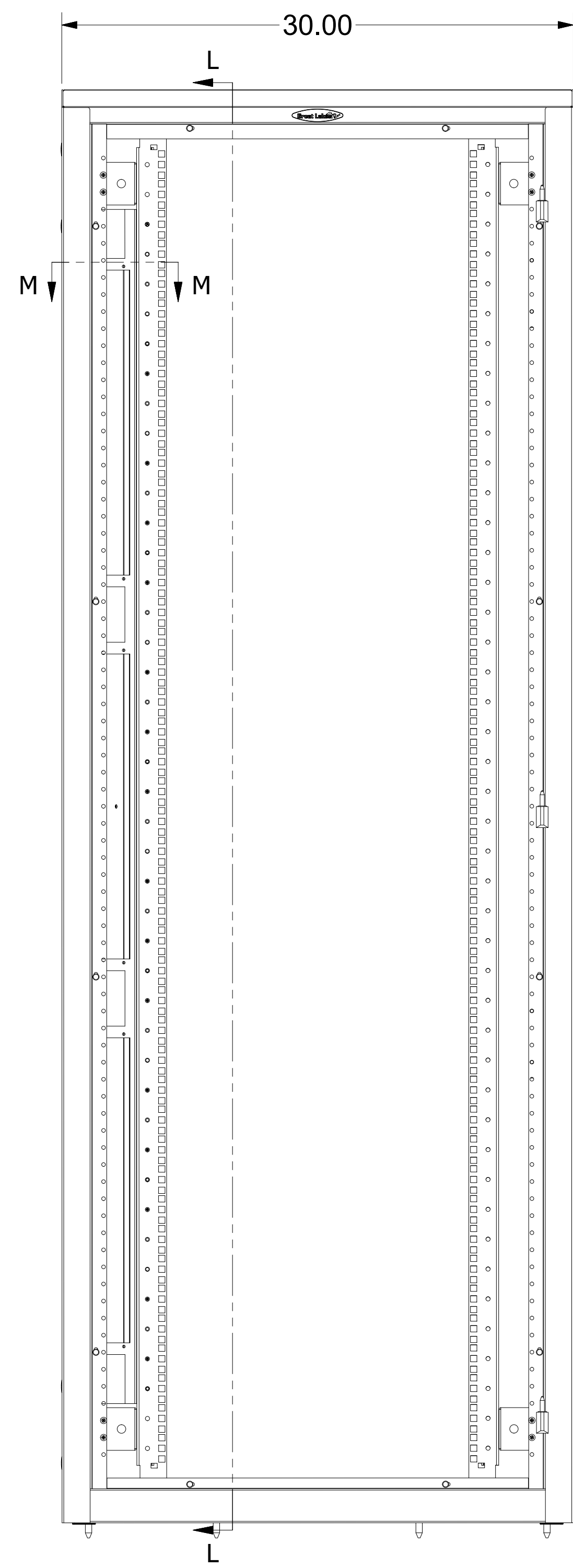

SECTION L-L

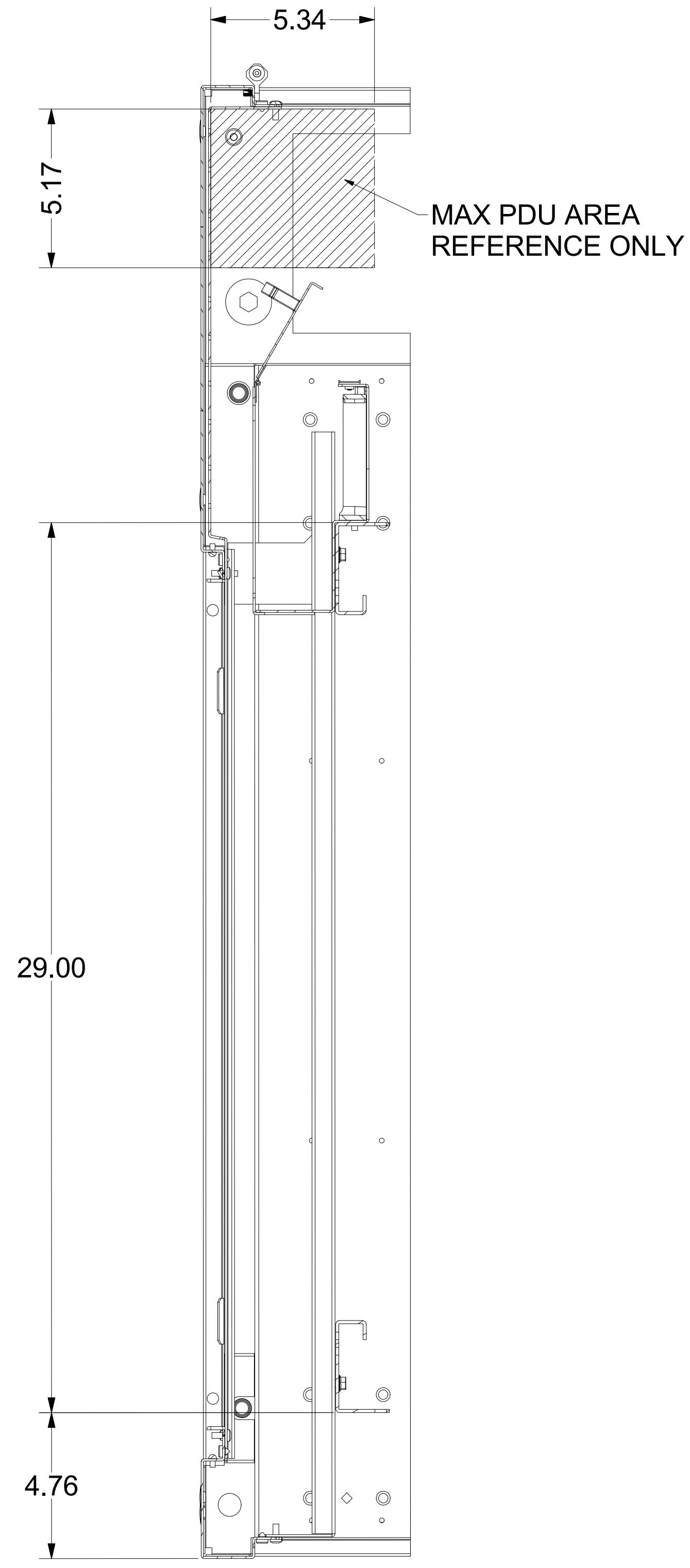

SECTION M-M
TOP INSIDE VIEW

48"D ES, VCM84K ON REAR

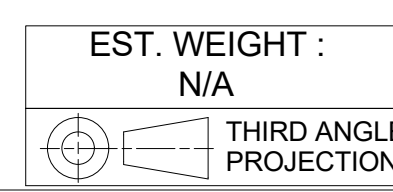

EST. WEIGHT :
N/A

INTERPRET DRAWING PER ASME Y14.5M-1994
DIMENSIONAL LIMITS APPLY
AFTER APPLICATION OF FINISH
DRAWING NOT TO SCALE
TOLERANCE UNLESS OTHERWISE NOTED:
ANGULAR +/- 1'
.XXXX +/- .010
.XXX +/- .015
.XX +/- .030
.X FOR REF. ONLY
UNLESS OTHERWISE SPECIFIED
ALL DIMENSIONS ARE IN INCHES

NOTICE:
Use of this document is subject to a confidentiality and nondisclosure agreement with Great Lakes Case & Cabinet Co., Inc. (GLCC) and may not be reproduced, disclosed or utilized in whole or in part without prior written authorization from GLCC.

PART NUMBER:
MATERIAL TYPE:
MATERIAL GAUGE:
FINISH:
DRAWN VL
CHECKED & APP. DATE

TITLE
VCM84K 3048 REAR ONLY
SEE CHART
GREAT LAKES CASE & CABINET CO., INC.
P.O. BOX 551 EDINBORO, PA 16412
PHONE (814) 734-7303 FAX (814) 734-3907
E-MAIL glcc@greatcabinets.com
DWG NO: **VCM84K INSTALLED**
REV
SHEET: 7 OF 7

8 7 6 5 4 3 2 1