



TECHNICAL SPECIFICATIONS

Grade Level Box BULK ⑦ Series

36"/914 mm depth



24"/610 mm depth

Now with  Covers

FEATURES

- Upgradeable
- Lightweight/Strong (TIER 22)
- Patented Anti-Slip Technology
- Anti-Seize Bolt Technology
- Industry Leader in Anti-Trip Hazard Prevention
- Superior Fatigue Resistance (EST)[™]
- Vertical and Horizontal Rib Design
- Embedded Vertical Racking
- Reduced Installation Cost
- Highest Load Rating to Weight Ratio in the Industry

TESTING CRITERIA

Covers meet or exceed:

- EST[™] 3 Million Cycles
- Telcordia GR-902-CORE
- Western Underground Committee Guide 3.6
- ANSI/SCTE 77 2013-TIER 22
- EN124 Class A15/B125

Bodies meet or exceed:

- Telcordia GR-902-CORE
- Western Underground Committee Guide 3.6
- ANSI/SCTE 77 2013-TIER 22
- EN124 Class A15/B125/C250
- ASTM-457
- AASHTO M-306 (H-20/25)
- AS3996-Class B/C



CHANNELL

channell.com

PRODUCT SUMMARY

With over 90 years experience in global (OSP) infrastructure, Channell has developed the most advanced pit and chamber technology in the world! Channell's BULK and SHIELD patented designs with the complement of SUPER BULK for roadway applications offer global users, consumer, and craft installers safety benefits never before contemplated, but critical when considering new global health and safety standards.

BULK's lightweight design increases installation efficiencies while improving overall body weight carrying load capacities versus concrete, polymer concrete, and many other body materials. Reduction of BULK's body weight protects the safety of installers while shortening installation times. Additionally, with BULK bodies, cutting ducts in the field produces no harmful dust contaminants which could lead to installer respiratory issues.

All SHIELD covers meet or exceed 33,750 pound-force or 150 kilonewtons in strength. They never break and offer a lid weight reduction over concrete and polymer concrete of 50%, and over 70% when compared to cast iron. SHIELD's lighter weight design cover reduces craft injuries while improving health and safety specifications.

Consumers also benefit from SHIELD's patented anti-slip design and anti-trip features. SHIELD's cover tread design raises global industry standards by offering 20% greater slip resistance when compared to concrete, polymer concrete, steel or cast iron covers. SHIELD meets and exceeds Australia AS4586 skid specification, the highest global standard in the world!

Overall, BULK's strength in combination with Channell's SHIELD covers offers a universal solution to meet and exceed every company's needs. Safety always comes first, and that's why BULK and SHIELD are tested to the highest standards available in the global market and Channell is proud to have pioneered Endurance Stress Testing (EST™) which analyzes cover fatigue in the field. EST™ provides essential data on the life expectancy of a SHIELD lid in the field and confirms its potential life expectancy. Product design, product innovation, safety attributes, and new manufacturing technology is why global customers are specifying Channell's BULK and SHIELD products for their new OSP infrastructure requirements.



STANDARD FEATURES



Anti-Slip Tread Design

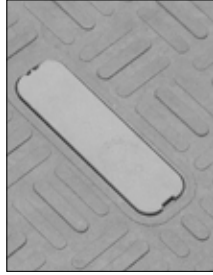

Anti-Trip Cover



Recessed Lifting Pin
with Cover



Non-Seizing Bolt System
Allows Field Replacement



Flush Mounted Sidewall Racks
Increase Usable Space



Mounting Studs



Logo Puck
(Custom Options Available)



Winterized Cable
Drop Slide

OPTIONAL FEATURES



L-Bolt Security System
(SHIELD Cover Shown)



Marker Locator Device



Swing-Arm with Butterfly
Mounting Plate



Cable Hook
Bracket



Step Bracket
with Wedge

Design and specifications may vary.

THE NEW SOLUTION

3 covers

Composite Ring
Optional

1 body



HDPE Plastic Cover
Light Duty 3,000 lbf (13.5 kN)



Composite Cover
33,750 lbf (150kN)



Ductile Iron Cover with Steel Ring
56,200 lbf (250 kN)
Available early 2017



BULK Vault Body
60,000 lbf (267 kN)

SPECIFICATION	PROOF LOAD	PRODUCTS
AMERICAS		
Pedestrian/Light Duty	3,000 lbf (13.5 kN)	 BULK
ANSI/SCTE 77 TIER 22	33,750 lbf (150 kN)	 BULK
AASHTO M-306-10 H 20	40,000 lbf (178 kN)	 BULK
AASHTO M-306-10 H 25	50,000 lbf (222.4 kN)	 BULK
ASTM-457	46,000 lbf (205 kN)	 BULK
EMEA		
Pedestrian/Light Duty	2,250 lbf (10 kN)	 BULK
EN 124 Class B125	28,100 lbf (125 kN)	 BULK
EN 125 Class C125	56,200 lbf (250 kN)	 BULK
APAC		
Pedestrian/Light Duty	3,370 lbf (15 kN)	 BULK
AS3996-Class B	18,000 lbf (80 kN)	 BULK
AS3996-Class C	33,750 lbf (150 kN)	 BULK

BODY DESIGN

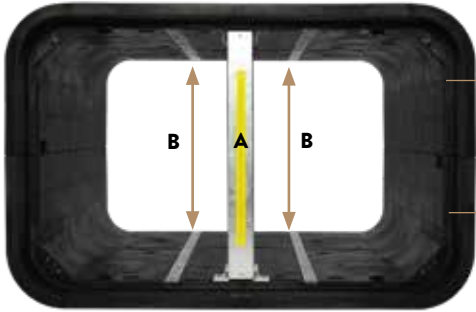

- A Crossbar Support
- B Standard flush mounted sidewall racks

Straight wall design improves lid load strength.

Flush mounted racks enhance sidewall and vertical strength of pit while increasing usable space.

Ribbed sidewall design secures body into backfill soil and eliminates sidewall deflection.



Stainless steel tube is constructed into sidewall of pit to prevent sidewall deflection on BULK bodies 24" (610 mm) and deeper.

HDPE bodies provide easy field alteration while eliminating water absorption and material degradation while maintaining structural integrity, and eliminating toxic fiberglass dust.



BODY SPECIFICATIONS

Cover Weight (Split 1/2 Cover)	50 lbs	[23 kg]
Pit Weight	129 lbs	[59 kg]
Assembled Weight	229 lbs	[105 kg]

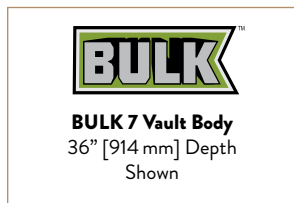
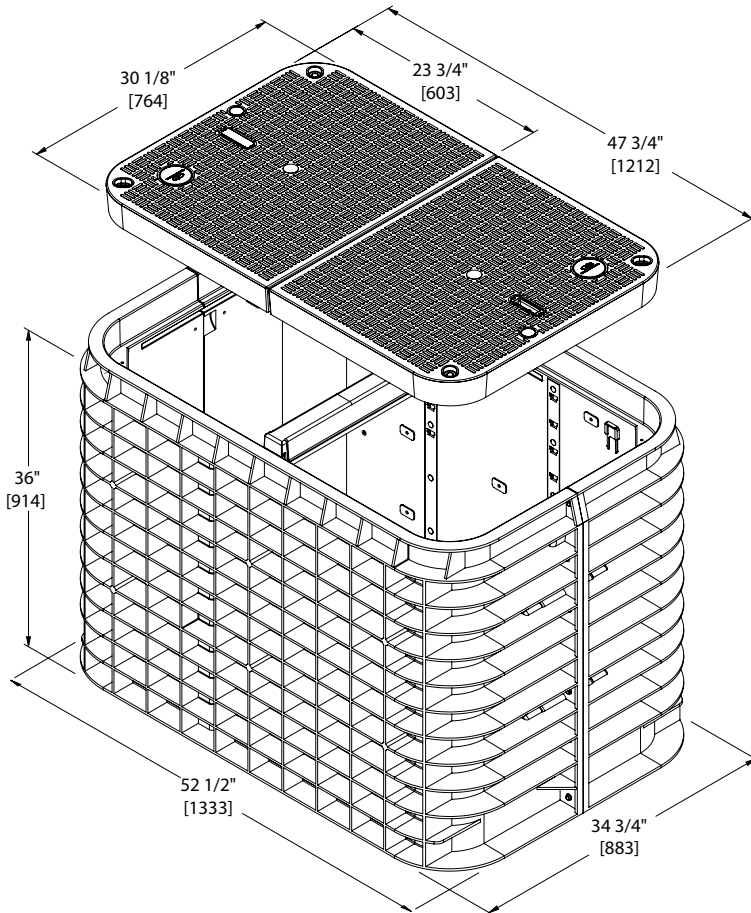

ADDITIONAL BODY DEPTHS

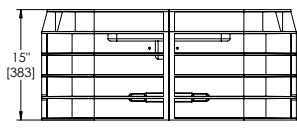

56 lbs [26 kg]

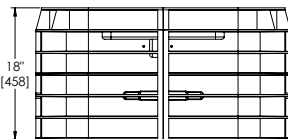

67 lbs [30 kg]

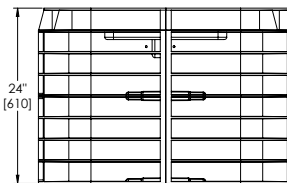

88 lbs [40 kg]

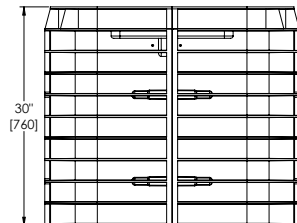

108 lbs [49 kg]



UNITED STATES
800.423.1863

CANADA
905.565.1700

EUROPE, MIDDLE EAST, AFRICA
44.1322.312590

AUSTRALIA, ASIA, PACIFIC RIM
61.2.8884.4111

www.channell.com