

## G6N GREEN HORNET ENCLOSURE

### 6 Splice Tray Series



The G6N represents the evolution of the legacy G6 product line but with the new Universal Splice Tray (UST) platform. The G6N can accommodate up to six (6) UST's capable of 216F single-fiber splicing capacity. A 16-port SC-APC bulkhead is available for use as a drop terminal. The 15" dome provides ample room for the splice tray stack and fiber routing while providing a completely sealed, waterproof solution.

The robust, field-proven design of the dome, base, and clamp remains unchanged and is compatible in a variety of applications including underground/vault, pedestal, and aerial installations.

The G6N grommets are designed to seal all types of incoming and drop cables in various diameters, constructions, and sizes.

### FEATURES

- **Environmentally Sealed: Air and Water Tight**
- **Craft-Friendly Design**
- **Quick and Tool-less Installation**
- **Re-enterable and Re-useable**

### TESTING SPECIFICATIONS

- **Meets GR771, IP68, and IEC 61300 test standards**

# UNIVERSAL SPLICE TRAY

Available with pre-installed splitters to reduce sourcing complexity and craft labor

Pre-connectorized SC-APC splitter outputs eliminates the need to terminate/splice in the field resulting in valuable labor cost savings and ensure factory tested quality/performance

Compatible with adapter bulkhead panel for mounting SC duplex and LC quad adapters

Eight duplex SC-APC adapter ports for up to 16 pre-connectorized drops for quick deployment

Clear, elongated dust caps facilitate finger-access for easy removal and accommodates VFL illumination for easier turn-up service and troubleshooting

Multiple strain relief holes add flexibility and security for incoming buffer tubes

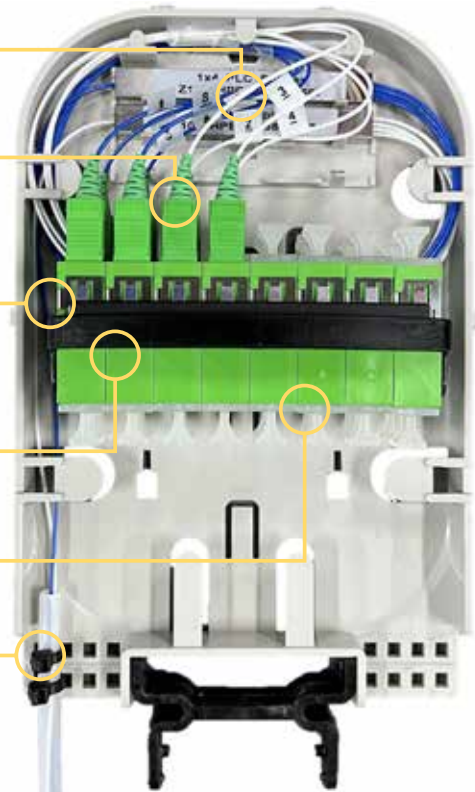

Available with up to three 6-slot splice chips for single-fiber or ribbon splicing (max splice capacity per tray of 36F single-fiber and 48F ribbon)

Designed for double stacking a wide range of splice sleeve types and diameters for high-density splicing in one tray. Horizontal placement so no need to cut fibers to length before splicing

Accepts industry standard 40mm and 60mm splice sleeves for 652.D standard fibers and 657.A1 bend insensitive fibers

Fiber retention clip provides additional buffer tube slack storage while extension arms avoid pinching inside the tray

Clear plastic tray cover ensures that all fiber and splicing is contained within the tray for added peace-of-mind

Splice tray pivot allows 90-degree tilt-rotate for easy access to splice chamber and bonding and grounding safety features

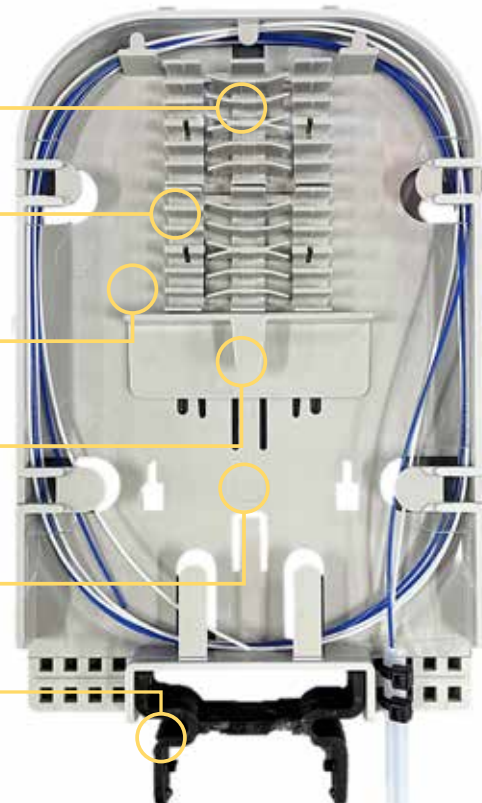

# PRODUCT DETAILS

Applications: underground/vault, pedestal, aerial

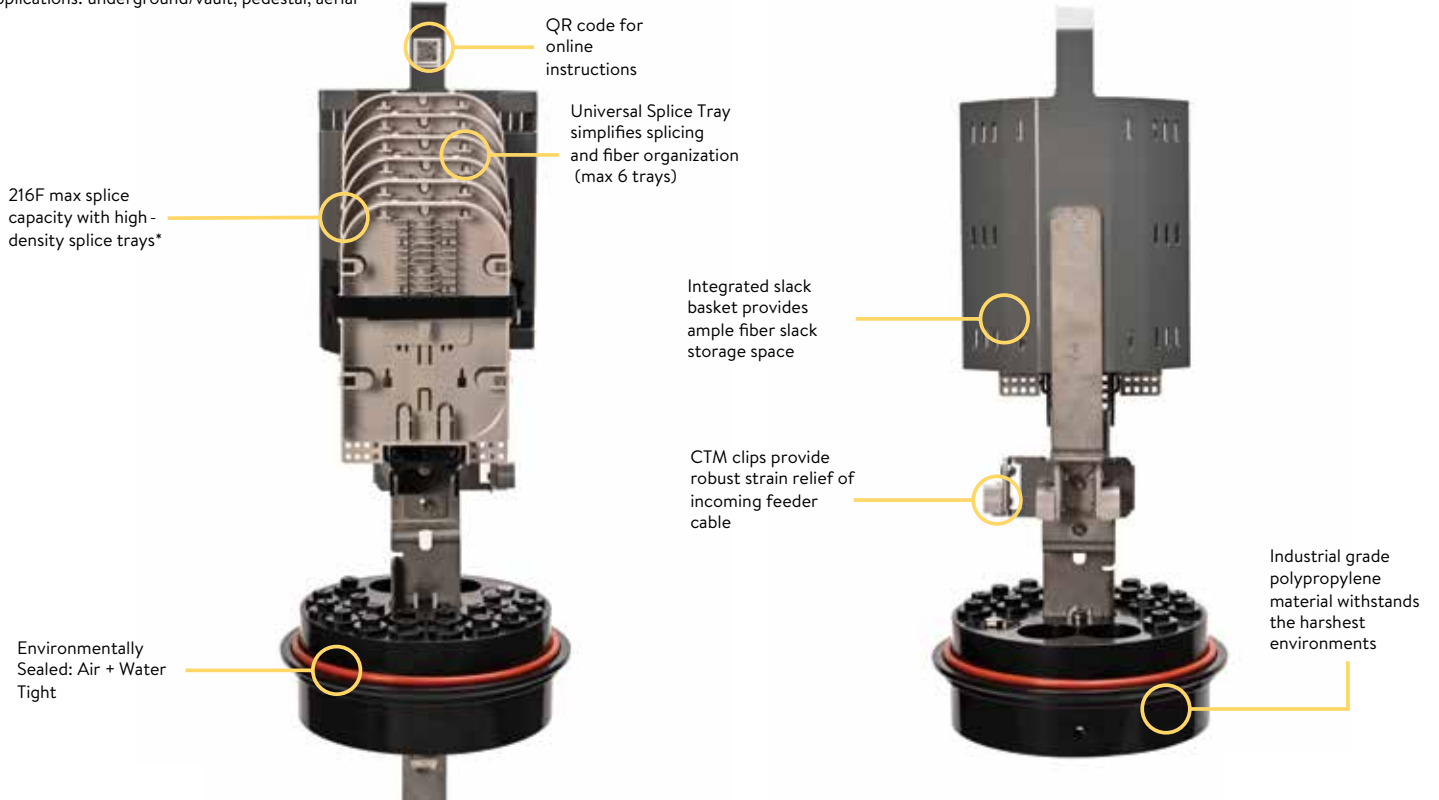

# DIMENSIONS



# PRODUCT DETAILS









## Packaging Information

Carton Dimensions	Pallet Dimensions	Pallet QTY	Truckload QTY
9-1/16" X 8-7/8" X 24"	41" x 49"	64	1792



# PRODUCT DETAILS

## Accessories

Image	Part Number	Description	Pack QTY
	USTKT-3	Universal Splice Tray Kit -Splice Tray with two 12-fiber single fusion splice holders (3-pack)	3
	USTKT-12	Universal Splice Tray Kit -Splice Tray with two 12-fiber single fusion splice holders (12-pack)	12
	USTKT-SF-12F	12-fiber single fusion splice holders for Universal Splice Tray (50-pack)	50
	USTKT-MF-48F	48-fiber mass fusion splice holders for Universal Splice Tray (50-pack)	50
	USTKT-SPL-3	3-position PLC splitter holders for Universal Splice Tray (50-pack)	50
	USTKT-FBR-ORG	Fiber organizer for Universal Splice Tray (50-pack)	50
	BR06018090 PMK	Green Hornet Closure Pole Mount Bracket (12-pack)	12
	BR3100- 00240PK	Green Hornet Closure Cable Slack Storage Bracket (12-pack) Need BR06018090PMK to mount GX	12
	BCON4400- 00023-00	Connector, for Shield Bond /Pair Saver (24-pack)	24
	ADP-SCADN1-50	SC-APC Adapter, Duplex, No Flange (50-pack)	50

# PRODUCT DETAILS



PLC Splitter

## Splitters

Part Number	Description
SPL1X02CNAANPPK	Splitter 1x2 PLC 60x7x4, 1.5m splice input, 0.3m SC-APC output, 12-pack
SPL1X04CNAANPPK	Splitter 1x4 PLC 60x7x4, 1.5m splice input, 0.3m SC-APC output, 12-pack
SPL1X08CNAANPPK	Splitter 1x8 PLC 60x7x4, 1.5m splice input, 0.3m SC-APC output, 12-pack
SPL1X16CNAANPPK	Splitter 1x16 PLC 60x12x4, 1.5m splice input, 0.3m SC-APC output, 12-pack
SPL1X02DNDNNPPK	Splitter 1x2 PLC 60x7x4, 2m splice input, 2m output, 12-pack
SPL1X04DNDNNPPK	Splitter 1x4 PLC 60x7x4, 2m splice input, 2m output, 12-pack
SPL1X08DNDNNPPK	Splitter 1x8 PLC 60x7x4, 2m splice input, 2m output, 12-pack
SPL1X16DNDNNPPK	Splitter 1x16 PLC 60x7x4, 2m splice input, 2m output, 12-pack
SPL1X32DNDNNPPK	Splitter 1x32 PLC 60x7x4, 2m splice input, 2m output, 12-pack

## Recommended Configurations

Part Number	Description
G6NBA1S00NNNN	G6N, NO GROMMET, NO SPLITTER, (1) SPLICE TRAY
G6NBA2S00NNNN	G6N, NO GROMMET, NO SPLITTER, (2) SPLICE TRAY
G6NBA3S00NNNN	G6N, NO GROMMET, NO SPLITTER, (3) SPLICE TRAY
G6NBA3SA0NNNN	G6N, NO GROMMET, NO SPLITTER, SC-APC, (3) SPLICE TRAYS
G6NBA6S00NNNN	G6N, NO GROMMET, NO SPLITTER, (6) SPLICE TRAYS
G6NBA5SA0NNNN	G6N, NO GROMMET, NO SPLITTER, (5) SPLICE TRAYS, 16 SC/APC PORTS
G6NSBA1AA0NN0NNN	G6N, NO GROMMET, 1X2 SPLITTER SCAPC, (3) SPLICE TRAYS
G6NSBA1AS0NN0NNN	G6N, NO GROMMET, 1X2 SPLITTER LEADS ONLY, (2) SPLICE TRAYS
G6NSBA1BA0NN0NNN	G6N, NO GROMMET, 1X4 SPLITTER SCAPC, (3) SPLICE TRAYS
G6NSBA1BS0NN0NNN	G6N, NO GROMMET, 1X4 SPLITTER LEADS ONLY, (2) SPLICE TRAYS
G6NSBA1DA0NN0NNN	G6N, NO GROMMET, 1X8 SPLITTER SCAPC, (3) SPLICE TRAYS
G6NSBA1DS0NN0NNN	G6N, NO GROMMET, 1X8 SPLITTER LEADS ONLY, (2) SPLICE TRAYS
G6NSBA2BA0NN0NNN	G6N, NO GROMMET, (2) 1X4 SPLITTER SC/APC (1 BLUE & 1 WHITE), (3) SPLICE TRAYS

# G6N PART NUMBER MATRIX

	G	6	N	X	X	X	X	X	X	X	X	X	X	X
Green Hornet _____														
Size 6" Diameter _____														
Next Generation _____														
Base Type _____														
B           Branch Base														
Sealing Type _____														
A           No Grommet														
Tray Count _____														
1           1 Tray														
2           2 Trays														
3           3 Trays														
4           4 Trays														
5           5 Trays (splice only or 4 splice + 1 adapter)														
6           6 Trays (splice only)														
Tray Type _____														
R           Ribbon (One Ribbon Splice Holder per Tray)														
S           Single Splice (Two Splice Holders per Tray)														
T           Single Splice (Three Splice Holders per Tray)														
Adapter Type* _____														
0           None or Not Applicable														
A           SC-APC (16 ports) *														
Brackets _____														
0           None														
Valve Option _____														
N           No Air Valve														
V           Air Valve														
Adder / Options _____														
N   None														
F   BULKU1324180061011   BULK Shield 1324, 18" Deep, Fiber Optic Logo														
G   BULKU1730248061011   BULK Shield 1730, 24" Deep, Fiber Optic Logo														
H   BULKU2436248061011   BULK Shield 2436, 24" Deep, Fiber Optic Logo														
J   BULKU1324180011011   BULK Plastic 1324, 18" Deep, Fiber Optic Logo														
K   BULKU1730248011011   BULK Plastic 1730, 24" Deep, Fiber Optic Logo														
L   BULKU2436248011011   BULK Plastic 2436, 24" Deep, Fiber Optic Logo														
Q   GOAT Pedestal 1010   Dark Green, Fiber Optic Logo Disk ....Hex Self-Lock + Mtg Bracket (8090)														
T   GOAT Pedestal 1212   Dark Green, Fiber Optic Logo Disk ... Hex Self-Lock + Tilt/Mtg Bracket (8090)														
U   GOAT Pedestal 1420   Dark Green, Fiber Optic Logo Disk ... Hex Self-Lock + Tilt/Mtg Bracket (8090)														
V   Signature Pedestal 1432   Dark Green, Horizontal Support Rod ... Hex Self Lock														
Bonding / Grounding _____														
N   None														
A   Flat Ground Braid + Bond Clips														
N _____														

\* SC-APC adapter option will require a minimum of 3 trays

# G6NX PART NUMBER MATRIX

	G	6	N	X	X	X	X	X	X	X	X	X	X
Green Hornet													
Size 6" Diameter													
Next Generation													
Splitter Series Type													
C	ConnectORIZED Splitter Series												
E	Engineered Tap Series												
S	Standard Splitter Series (Splice or Connectorized Outputs)												
Base Type													
B	Branch Base												
Sealing Type													
A	No Grommet												
Splitter Quantity													
0, 1, 2, 3, 4, 5, 6, 7, 8, or 9													
Primary Splitter Type													
N	None (Not Applicable)												
A	1x2 (Leads Only Max 9) (SC Type Max 8)												
B	1x4 (Leads Only Max 6) (SC Type Max 3)												
C	2x4 (Leads Only Max 6) (SC Type Max 3)												
D	1x8 (Leads Only Max 6) (SC Type Max 2)												
E	2x8 (Leads Only Max 6) (SC Type Max 2)												
F	1x16 (Leads Only Max 6) (SC Type Max 1)												
G	2x16 (Leads Only Max 6) (SC Type Max 1)												
H	1x32 (Leads Only Max 3) (SC N/A)												
Connectorized Options													
N	None (Not Applicable)												
S	Splice Only (Leads)												
A	SC-APC												
Splitter Quantity													
0, 1, 2, 3, 4, 5, 6, 7, 8, or 9													
Secondary Splitter Type													
N	None (Not Applicable)												
A	1x2 (Leads Only Max 9) (SC Type Max 8)												
B	1x4 (Leads Only Max 6) (SC Type Max 3)												
C	2x4 (Leads Only Max 6) (SC Type Max 3)												
D	1x8 (Leads Only Max 6) (SC Type Max 2)												
E	2x8 (Leads Only Max 6) (SC Type Max 2)												
F	1x16 (Leads Only Max 6) (SC Type Max 1)												
G	2x16 (Leads Only Max 6) (SC Type Max 1)												
H	1x32 (Leads Only Max 3) (SC N/A)												
Connectorized Options													
N	None (Not Applicable)												
S	Splice Only (Leads)												
A	SC-APC												
Adder/Options													
N	None												
F	BULKU1324180061011	BULK Shield 1324, 18" Deep, Fiber Optic Logo											
G	BULKU1730248061011	BULK Shield 1730, 24" Deep, Fiber Optic Logo											
H	BULKU2436248061011	BULK Shield 2436, 24" Deep, Fiber Optic Logo											
J	BULKU1324180011011	BULK Plastic 1324, 18" Deep, Fiber Optic Logo											
K	BULKU1730248011011	BULK Plastic 1730, 24" Deep, Fiber Optic Logo											
L	BULKU2436248011011	BULK Plastic 2436, 24" Deep, Fiber Optic Logo											
Q	GOAT Pedestal 1010	Dark Green, Fiber Optic Logo Disk ... Hex Self-Lock + Mtg Bracket (8090)											
T	GOAT Pedestal 1212	Dark Green, Fiber Optic Logo Disk ... Hex Self-Lock + Tilt/Mtg Bracket (8090)											
U	GOAT Pedestal 1420	Dark Green, Fiber Optic Logo Disk ... Hex Self-Lock + Tilt/Mtg Bracket (8090)											
V	Signature Pedestal 1432	Dark Green, Horizontal Support Rod ... Hex Self Lock											
Bonding / Grounding													
N	None												
A	Flat Ground Braid + Bond Clips												



**CHANNELL**

Where The Industry Connects.

[www.channell.com](http://www.channell.com)

All specifications subject to change without notice. © 2024 Channell Commercial Corporation. All rights reserved.