



# Optima S Enclosure

Scan QR for website.



## Table of Contents

<b>General</b> .....	3
<b>1. Introduction</b> .....	3
1.1 Product Description	
1.2 Optima S      Dimensional Drawing	
<b>2. Preparations</b> .....	4
2.1 Installation Outline	
2.2 Optima S Checklist	
2.3 Recommended Tools and Equipment	
<b>3. General Warnings</b> .....	5
3.1 Laser Light Warning	
3.2 Laser Light Magnification Warning	
3.3 Loose Fiber Warning	
3.4 Sharp Edge Warning	
3.5 Safety Glasses Warning	
3.6 Electrical Shock Warning	
3.7 Fiber Damage Warning	
<b>4. Installation</b> .....	6
<b>Entry Cable Preparations</b> .....	6
4.1 Entry Cable Prep	
4.2 Cable Jacket Removal	
4.3 Cut & Trim CSM	
4.4 Armored Cable	
4.5 Grounding Kit <i>*sold separately</i>	
4.6 Connecting the Grounding Braid	
4.7 Drill Ground Lug Hole	
4.8 Insert Ground Lug	
4.9 Secured Grounding	

Table of Contents Continues on Page 2

## Contact Us

North America	Europe, Middle East & Africa	Latin & South America
Tel: +1 440 366 6966	Tel: +1 440 366 6966	Tel: +1 440 366 6966
Fax: +1 440 366 6802	Fax: +1 440 366 6802	Fax: +1 440 366 6802
Email: <a href="mailto:engsupport@gomultilink.com">engsupport@gomultilink.com</a>	Email: <a href="mailto:engsupport@gomultilink.com">engsupport@gomultilink.com</a>	Email: <a href="mailto:lasupport@gomultilink.com">lasupport@gomultilink.com</a>



INSTALLATION



## Table of Contents (Cont.)

<b>Optima S Base Installation</b> .....	8
4.10 Install CSM Clamp	
4.11 Fiber Management Clips	
4.12 Proper Grommet Seal	
4.13 Install CSM & Cable Grommet	
4.14 Secure Cable to Base	
4.15 Fiber Routing & Attach Tie-Wraps	
4.16 Buffer Tube Branching	
4.17 Attach Tie-Wraps	
<b>Splicing Buffer Tube to Pigtail</b> .....	10
4.18 Splice Input Fiber to Pigtail	
4.19 Splice Tray Routing	
4.20 Attach Splice Tray	
4.21 Attach Splice Tray Cover	
4.22 Pigtail & Branch Buffer Tube Routing	
<b>Optima S Hinged Shell Installation</b> .....	11
4.23 Fiber Management & Tie-Wraps	
4.24 Pigtail Fiber Routing	
4.25 Fiber Management	
4.26 Bulkhead Adapter(s) & Connector(s)	
4.27 Sealing the Gap	
4.28 Closing the Fiber Closure	
4.29 Apply Sealant to the Perimeter	
4.30 Start to Connect Cover to Base	
4.31 Tighten Bolts to S-Base	
<b>Optima S Distribution Installation</b> .....	14
4.32 Install Optidrop(s)	
4.33 Install Optidrop Fiber Connector	
4.34 Apply Sealant Directly to Gel	
4.35 Latch Cover to Optima Shell	
<b>5. Accessory List</b> .....	15

### Contact Us

North America	Europe, Middle East & Africa	Latin & South America
Tel: +1 440 366 6966 Fax: +1 440 366 6802 Email: <a href="mailto:engsupport@gomultilink.com">engsupport@gomultilink.com</a>	Tel: +1 440 366 6966 Fax: +1 440 366 6802 Email: <a href="mailto:engsupport@gomultilink.com">engsupport@gomultilink.com</a>	Tel: +1 440 366 6966 Fax: +1 440 366 6802 Email: <a href="mailto:lasupport@gomultilink.com">lasupport@gomultilink.com</a>

## General

This installation guide provides instructions for preparation, installation and application of Multilink's Optima closure. This product provides a solution for in-line access to the fiber optic trunk line and quick connection to subscribers single drop cable or to low count drop, feeder or lateral cable to be connected to single drop cable at another location. This guide is for installers who are familiar with fiber optic cable systems and their applications.

## 1. Introduction

### 1.1 Product Description

Multilink's Optima S closure allows a FTTX provider to access the fiber optic trunk line (that is deployed from the central office, headend, or remote hub) and branch connections off to individual subscribers (such as home, apartment, or individual business). Connections can also be branched off to low count drop cables to feed another terminal point. Contact Multilink at (440) 366-6966 for assistance for FTTX network planning and FTTX deployment products.

### 1.2 Optima S Dimensional Drawing

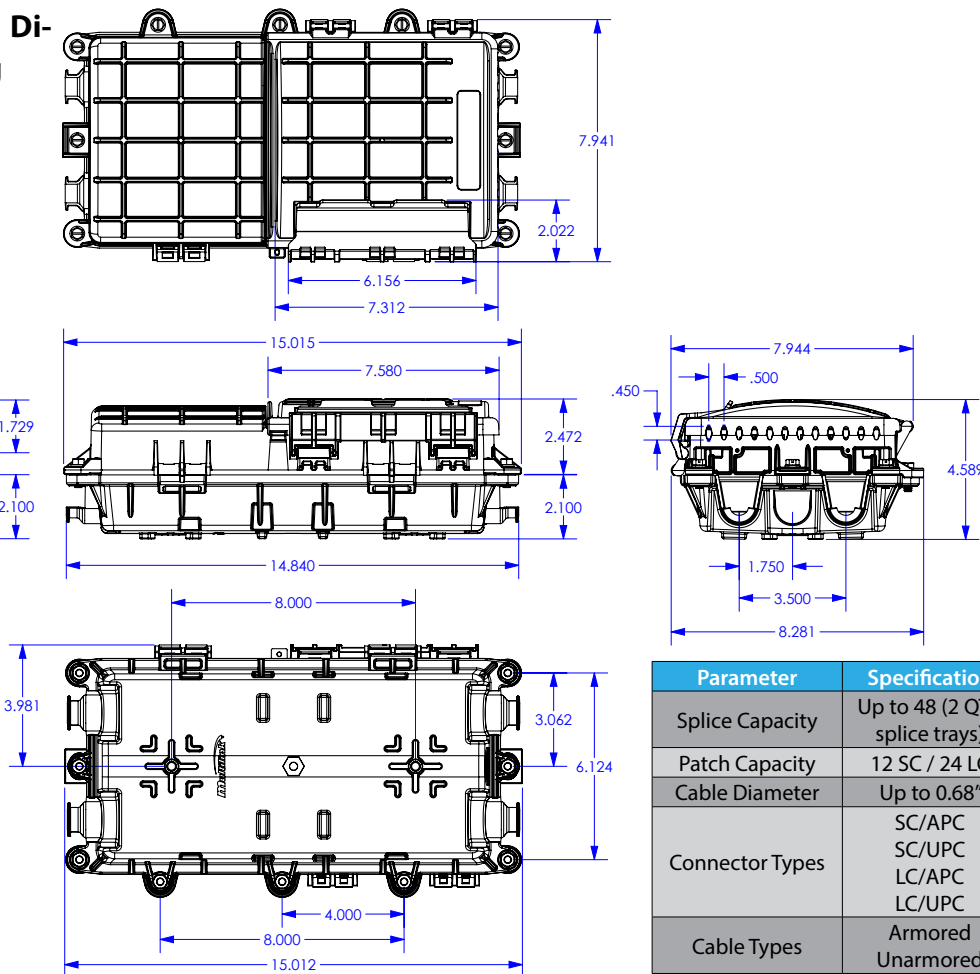

Parameter	Specification
Splice Capacity	Up to 48 (2 QTY splice trays)
Patch Capacity	12 SC / 24 LC
Cable Diameter	Up to 0.68"
Connector Types	SC/APC SC/UPC LC/APC LC/UPC
Cable Types	Armored Unarmored

### Contact Us

North America	Europe, Middle East & Africa	Latin & South America
Tel: +1 440 366 6966	Tel: +1 440 366 6966	Tel: +1 440 366 6966
Fax: +1 440 366 6802	Fax: +1 440 366 6802	Fax: +1 440 366 6802
Email: <a href="mailto:engsupport@gomultilink.com">engsupport@gomultilink.com</a>	Email: <a href="mailto:engsupport@gomultilink.com">engsupport@gomultilink.com</a>	Email: <a href="mailto:lasupport@gomultilink.com">lasupport@gomultilink.com</a>

## 2. Preparations

### 2.1 Installation Outline

The general procedure of the Optima S installation includes:

- Removal of cable jacketing and excess CSM (Central Strength Member)
- Ring cut, fiber separation, CSM tie down, and routing fiber
- Securing fiber in place to the Optima S closure
- Configuring grommets for cable entry and exit drop
- Splicing and fiber termination

### 2.2 Optima S Checklist

Each kit includes the following items:

- 1x Optima S Assembly (A)
- 1x Splice Tray Kit (B)
- 1x Hardware Kit (C)

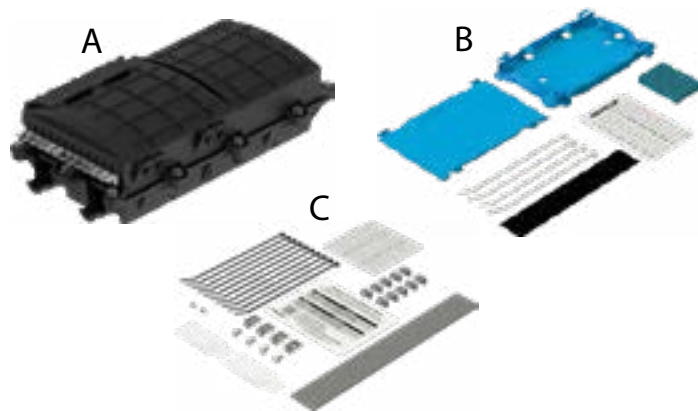

### 2.3 Recommended Tools and Equipment

The Following list includes tools and equipment that you may need for a successful installation (these tools **ARE NOT INCLUDED with the product or accessories**):

- Safety Glasses
- Cut-Resistant Gloves
- Torque Screw Driver (inch pounds)
- Phillips Screw Driver
- Scissors / Razor Knife
- Tape Measure
- Side Cutters/Diagonal Cutters
- Fiber Strippers
- Colored Marker(s)
- Ring Cut Tool
- Mastic Tape

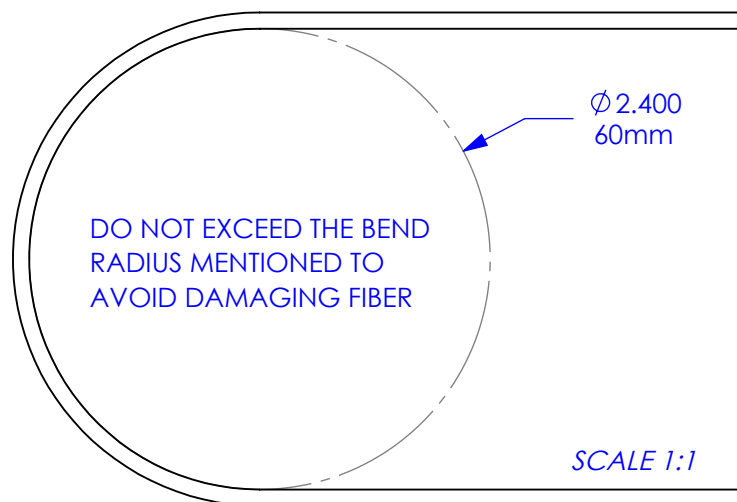

**BEND RADIUS GAUGE**

#### Contact Us

North America	Europe, Middle East & Africa	Latin & South America
Tel: +1 440 366 6966 Fax: +1 440 366 6802 Email: <a href="mailto:engsupport@gomultilink.com">engsupport@gomultilink.com</a>	Tel: +1 440 366 6966 Fax: +1 440 366 6802 Email: <a href="mailto:engsupport@gomultilink.com">engsupport@gomultilink.com</a>	Tel: +1 440 366 6966 Fax: +1 440 366 6802 Email: <a href="mailto:lasupport@gomultilink.com">lasupport@gomultilink.com</a>

## 3. General Warnings



### 3.1 Laser Light Warning

Never look directly into the end of a fiber that may be carrying laser light. Laser light can be invisible and may be harmful to your eyes. Viewing it directly may not cause pain; therefore it will not cause blinking or the iris of the eye to close involuntarily as it does when viewing bright light. Consequently, serious damage to the retina of the eye is possible. Should accidental exposure of laser light be suspected, arrange an eye exam immediately.



### 3.2 Laser Light Magnification Warning

Do not use magnifiers in the presence of laser radiation. Diffused laser light can cause serious eye damage if focused with optical instruments.



### 3.3 Loose Fiber Warning

Cleaved or broken glass fibers are very sharp and can pierce the skin easily. Keep your work area clear of removed fiber. Do not allow pieces of fiber to stick to your clothing or fall into the work area where they can cause injury later. Use tweezers to pick up broken/cut pieces of fiber and place on a piece of tape that has been set aside for this purpose.



### 3.4 Sharp Edge Warning

The wearing of cut-resistant safety gloves to protect your hands from sharp cutting tools and the metal armoring of armored cable is strongly recommended. Use extreme care when working with severed armor. There may be sharp edges where the armor is damaged. Always cover the exposed/cut armor end with a wrap of black electrical tape. To minimize the chance of injury from sharp-blade tools, always cut away from yourself and others. Dispose of used blades and armor scrap properly.



### 3.5 Safety Glasses Warning

Use safety glasses while working is highly recommended to provide eye protection from accidental injury when handling chemicals, cables or working with fiber. Pieces of glass fiber are very sharp and have potential to damage the eye.



### 3.6 Electrical Shock Warning

Do not install telecommunications equipment or work with telephone wiring during a lightning storm. Telephone lines can carry high voltages from lightning causing electrical shock resulting in severe injury or death.



### 3.7 Fiber Damage Warning

Fiber Optic cable is highly sensitive to excessive pulling, bending and crushing. Take care when bending the cables. Be sure not to pull too hard on the fibers. Do not crush the cable or allow it to kink. Doing any of these things may cause damage to the fiber and require it to be replaced.

## 4. Installation

### Entry Cable Preparations

Note: Fiber optic cable is sensitive to excessive pulling, bending, and crushing forces. Consult the cable specification sheet for the cable you are installing. **Do not bend the cable more sharply than the minimum recommended bend radius. Do not apply more pulling force to the cable than specified. Do not crush the cable or allow it to kink.** Doing so may cause damage that can alter the transmission characteristics of the cable; the cable may have to be replaced.

#### 4.1 Entry Cable Prep

Measure 72" inches of cable and mark two spots on each end. Using the appropriate tool, make a ring cut at both locations. Carefully make a horizontal cut from one circle cut to the other. During the cutting process, be sure not to damage the buffer tubes inside the cable.

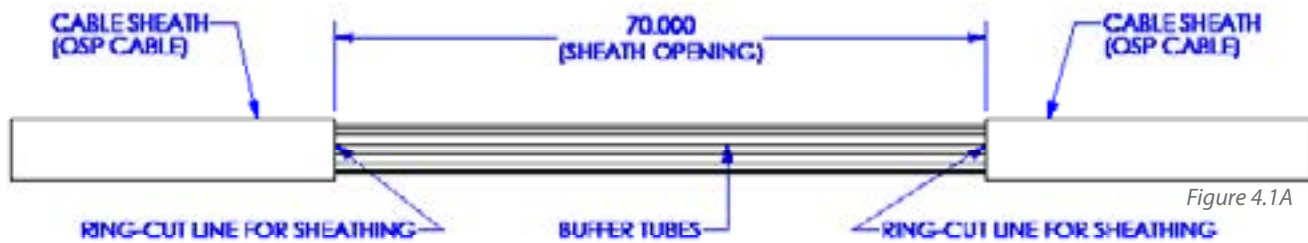

#### 4.2 Cable Jacket Removal

Find the rip cord in the cable and pull to help separate the jacket from the cable. Remove the outer jacket and trim away all the protective layers leaving the Central Strength Member (CSM) and buffer tubes exposed across the length of the ring cut.

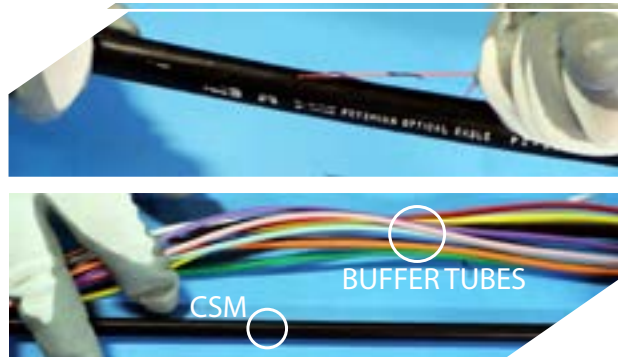

#### 4.3 Cut & Trim CSM

Measure 2" inches from each side of the ring cut locations with the exposed buffer tubes and make a mark on each side of the CSM (Figure 4.3A). Cut and trim the CSM discarding the 66" inch section (Figure 4.3B). If using armored cable continue to 4.4, else continue to 4.8.

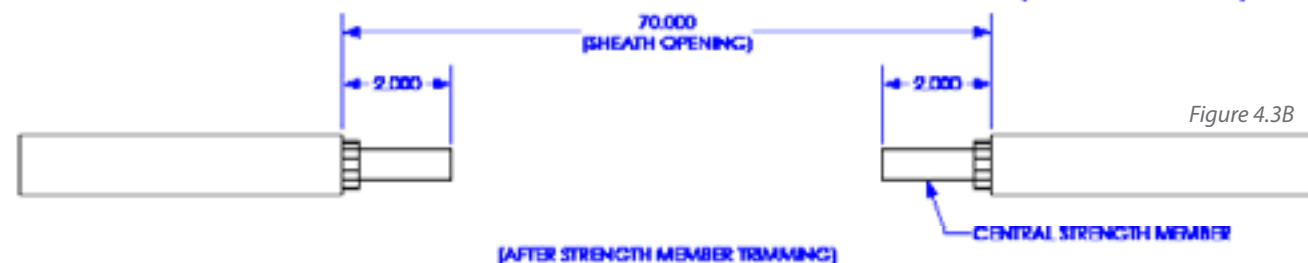



## Installation (Cont.)

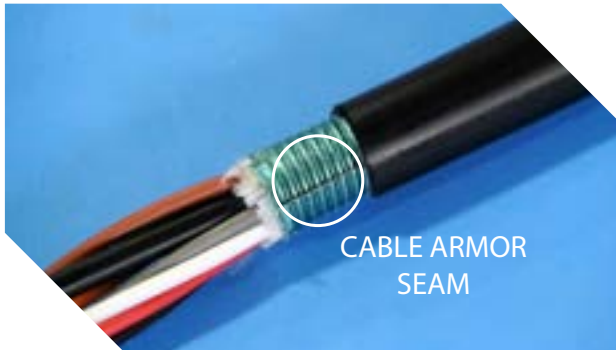

### 4.4 Armored Cable

Allow at least 1" of the cable's armor to remain from the jacketing. Slowly peel back the armor using pliers to separate the seam to allow the wedge\* (from the grounding kit, **\*sold separately**) to fit between the buffer tubes and armor. Repeat on opposite side of ring cut.

### 4.5 Grounding Kit *\*sold separately*

Allow at least 1" of the cable's armor to remain from the jacketing. Slowly peel back the armor using pliers to separate the seam to allow the wedge\* (from the grounding kit, **\*sold separately**) to fit between the buffer tubes and armor. Repeat on opposite side of ring cut.

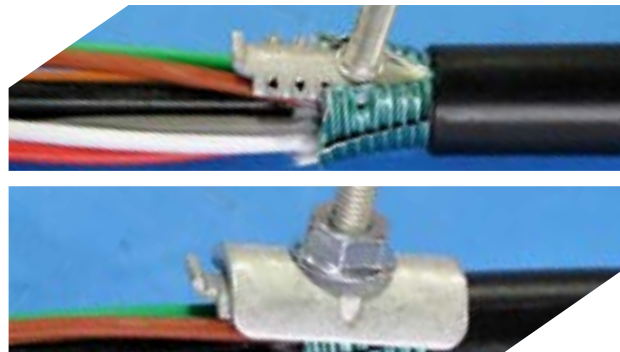

### 4.6 Connecting the Grounding Braid

Attach the grounding braid by using the bolt as a guide. Insert the bolt through the eyelet and using one of the supplied nuts tighten to secure the grounding braid to the armored entry cable. Repeat on opposite side of ring cut.

### 4.7 Drill Ground Lug Hole

Drill a 0.25" hole into the center of the Optima S base indicated by the raised circular area between the 2 main grommets on either end, as shown. Either end may be used.



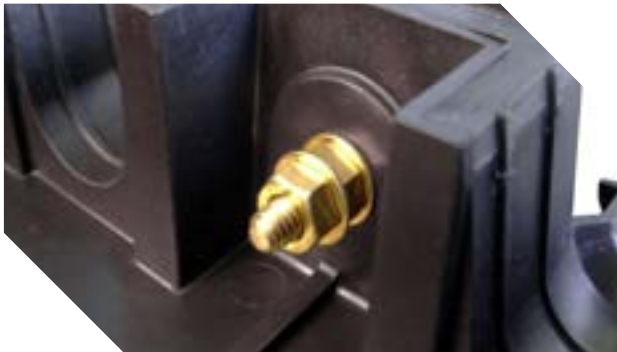

#### 4.8 Insert Ground Lug

Insert the supplied ground lug with the terminal lug on the outside of the Optima S compressing the rubber seated gasket to the outside of the enclosure to ensure a water tight seal. With the long threaded end on the inside of

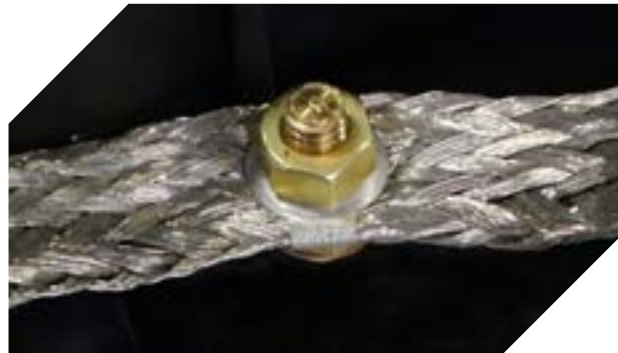

the enclosure, attach the ground lug to the base by using the supplied washer and nut(s).



#### 4.9 Secured Grounding

Attach the grounding braid by using the ground lug as a guide. Use the appropriate eyelet to allow both sides of the ring cut to be mounted in the following step. Then attach the additional washer and nut to the ground lug to secure the braid in place.

### Optima S Base Installation





#### 4.10 Install CSM Clamp



Attach the CSM clamp to the base of the Optima S using the supplied hardware. Be sure to install both clamps on the opposite entry ports of the base to accommodate the ring cut. **DO NOT** tighten the CSM clamp all the way down but just loose enough to slide the CSM under the clamp.

#### 4.11 Fiber Management Clips

Insert the included fiber management clips into the slots of the Optima S base in the orientation shown. Ensure each clip is fully pushed in to prevent it from falling out in later steps. Insert 2 additional fiber management clips into the top section to secure the fiber pigtailed into the back of the bulkhead connectors.



#### 4.12 Proper Grommet Seal

Make sure each fiber jacketing/entry grommet is the appropriate size of the cable and/or mastic tape applied to accommodate the diameter being used. Remove the white protective cover on the mastic tape prior to applying to

the fiber and securing in the grommet. Any drop grommets not being used **MUST** have a supplied pin inserted to ensure a water-tight seal.



#### 4.13 Install CSM & Cable Grom-



#### met

Place the fiber jacketing into the appropriate sized non-captive grommet. If necessary build up the diameter to fit within the grommet using mastic tape. Prior to installation, use sealant to lubricate the fiber jacketing or mastic tape as well as the outer edge of the grommet for a proper seal. Adjust the CSM under the CSM clamp so that the jacket is barely exposed

and the 2" of CSM doesn't stick too far out of the clamp as shown. Once positioned tighten the screw of the CSM clamp to secure into place.



#### 4.14 Secure Cable to Base



After your fiber is bound via the CSM clamp, utilize the supplied hose clamp to secure the fiber/s to the non-captive entry flange. Tighten until secure being sure to not overtighten to bend or flex the fiber out of the grommet. Doing so will involve a water leakage to occur.

#### 4.15 Fiber Routing & Attach Tie-Wraps

Route the ring cut exposed buffer tubes around the inside perimeter of the Optima S base. Place the slack under the fiber management clips to hold in place temporary. Then using the supplied tie-wraps insert into each fiber management clip on the lower side of the base and tighten down enough to hold in place but not



directly damage the fiber.



#### 4.16 Buffer Tube Branching

Determine the number of buffer tubes that will need to be branched off to be spliced. Cut these select buffer tubes on the exit side (full length of the ring cut) and separate these from the remainder buffer tubes that will pass through. Utilize lower fiber management clips to secure your "Feed Through Fiber" and upper clips to



secure your spliced fibers.

#### 4.17 Attach Tie-Wraps

Using the supplied tie-wraps insert into each fiber management clip on the upper side of the base to hold the branched off buffer tubes.



### Splicing Buffer Tube to Pigtail

#### 4.18 Splice Input Fiber to Pigtail

Following your splicers manual, splice the appropriate number of fibers from the branched off buffer tube to that of the provided or separately purchased pigtail. *(Multilink is NOT responsible for any damages or drastic light loss if splicing is not performed by a trained technician following the necessary instructions.)*





## 4.19 Splice Tray Routing



Place the completed splice tray within the Optima S base. Route the branched off buffer tube(s) accordingly along with how the pigtail slack will be routed.



### 4.20 Attach Splice Tray

With the splice tray cover still removed, using the supplied screws secure the splice tray to the appropriate holes located in the Optima S base.

### 4.21 Attach Splice Tray Cover

Before finalizing the splicing section of the

Optima S attach the splice tray cover on the hinges of the splice tray base. The cover ensures that the fiber is secured from the internal buffer tubes from damaging the fiber itself or causing any service disruption.

### 4.22 Pigtail & Branch Buffer Tube Routing

Once everything has been successfully



Grooved Edge Ungrooved Edge

spliced and secured into place make



sure the pigtail fibers (spiral wrap shown) and the branched off buffer tube are routed following the buffer tubes below it. Using the inserted tie-wraps on each fiber management clip on the upper side of the base tighten down enough to hold in place but not directly damage the fiber.

## Optima S Hinged Shell Installation

### 4.23 Fiber Management & Tie-Wraps

Insert the included fiber management clips into the slots of the Optima S hinged shell in the orientation shown. Ensure each clip is fully pushed in to prevent it from falling out in later steps. Then using the supplied tie-wraps insert into each fiber

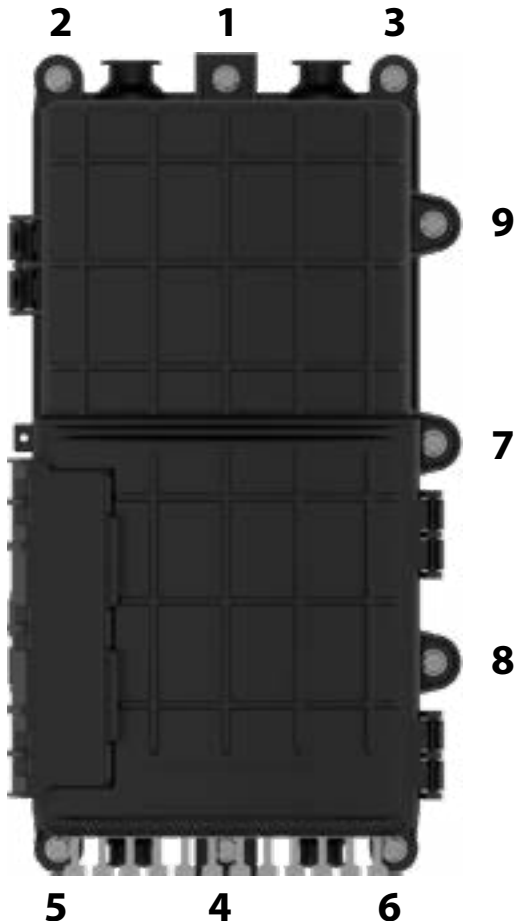

management clip on the shell to hold the fiber pigtail.



## 4.24 Pigtail Fiber Routing



Route the remaining slack of the fiber pigtail around the inside perimeter of the Optima S hinged shell. Place the slack under the fiber management clips to hold in place temporary.

### 4.25 Fiber Management

Using the supplied tie-wraps inserted into each fiber management clip on the Optima S shell tighten down enough to hold in place but not directly damage the fiber.



1. need new photo

### 4.33 Apply Sealant to Door Gasket

Before completely shutting the closure flush, apply one of the supplied sealant packets to the gasket perimeter of the Optima S drop section door. This will ensure a proper seal that prevents various elements from entering.



...g-in the pigtail connectors following the universal fiber color chart. DO NOT remove all the adapter covers at once. *(Multilink is not responsible for any fiber loss that may occur if this is performed improperly.)*

### 4.27 Sealing the Gap

Insert any additional grommets that are being used for the installation in the two open available locations. Prior to installation, use sealant to lubricate the outer edge of the grommet for a proper seal. In this case, we will use blank





## Installation (Cont.)





### 4.35 Hang the Optima







Now that the Optima has been latched, proceed to hang it horizontally with the latch on the top left of the unit and the strain relief brackets jutting out on the left.



grommets to seal up the opening.

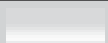

Ensure the grommets are inserted into the base in the correct orientation following the gasket over mold pattern.

Mounting Kits		
Products	Description	Stock ID
	Standard Tap Bracket Kit	072-391-21
	Aerial Tap Bracket Kit	072-579-10
	Surface Mounting Kit	072-365-10
	Accessory Rail Mounting Kit	072-584-10

Grommets		
Products	Description	Stock ID
	Plug Grommet	642-065-10
	Round Cable Grommet .48" Diameter	642-091-10
	Round Cable Grommet .58" Diameter	642-064-10
	(4) Flat Cable Grommet	642-089-10
	(4) Round Cable Grommet 3mm	642-089-20
	Flat Cable Pin	10-7726
	Round Cable Pin 3mm	649-261-10

## Installation (Cont.)

### Splice Tray

Products	Description	Stock ID
	12-SSTP	072-394-10
	1124-SSTP	072-059-20



### NPT Fittings

Products	Description	Stock ID
	1/2" NPT Fitting	072-567-10



### Ground Lug

Products	Description	Stock ID
	Grounding Lug	072-121-10

### Connectivity



Products	Description	Stock ID
	SC/APC Duplex Adapter	10-5378
	LC Quad UPC Adapter	065-239-10

### Drop Cable

Products	Description	Stock ID
	OptiDrop™	Custom
	Flat Drop Cable Protector	649-274-10

## 4.28 Closing the Fiber Closure

### Surelight® Field Installable Kits

Products	Description	Stock ID
	900µm Connector Kit	072-395-10
	IP Connector Kit	072-395-50
	OptiDrop™ Field Installable	072-560-10



Scan  
QR for  
website.

Multilink, Inc  
580 Ternes Ln  
Elyria, OH 44035  
Tel: (440) 366-6966  
Fax: (440) 366-6802



[facebook.com/GoMultilink1](https://facebook.com/GoMultilink1)



[twitter.com/GoMultilink](https://twitter.com/GoMultilink)



[youtube.com/GoMultilink](https://youtube.com/GoMultilink)

#### Contact Us

North America	Europe, Middle East & Africa	Latin & South America
Tel: +1 440 366 6966 Fax: +1 440 366 6802 Email: <a href="mailto:engsupport@gomultilink.com">engsupport@gomultilink.com</a>	Tel: +1 440 366 6966 Fax: +1 440 366 6802 Email: <a href="mailto:engsupport@gomultilink.com">engsupport@gomultilink.com</a>	Tel: +1 440 366 6966 Mobile: +1 440 366 6802 Email: <a href="mailto:lasupport@gomultilink.com">lasupport@gomultilink.com</a>