

RDT-XM04J00D1834A



RapidFiber® Mini-RDT, 1x4 Indexing Terminal, 3.6mm Black Riser I/O cable, female MPO at far end, 600 ft

- Designed to provide a quick and simple solution for installing fiber in small and medium sized MDU's
- Incorporates a unique fiber cable spooling system that stores up fiber cable within the enclosure
- Removes the need for field termination and extensive site survey inspections

Product Classification

Regional Availability	Asia Australia/New Zealand EMEA Latin America North America
Product Type	Fiber distribution terminal, indexed
Product Brand	RapidFiber®
Product Series	Mini-RDT

General Specifications

Adapters, quantity	4
Cable Color	Black
Cable Entry Location	Bottom left Bottom right
Cable Type	Indoor/outdoor - Stranded
Color	Gray
Distribution Type	1 x 4 splitter
Fibers per Feeder Cable, quantity	12
Front Cover Type	Hinged at top
Interface	SC/APC
Interface, stub	MPO
Mounting	Wall
Port, quantity	4
Splitter, quantity	1

Dimensions

Height	203.2 mm 8 in
Width	139.7 mm 5.5 in
Depth	60.96 mm 2.4 in

RDT-XM04J00D1834A

Cable Length 182.88 m | 600 ft

Outer Cable Diameter 4 mm | 0.157 in

Dimension Drawing

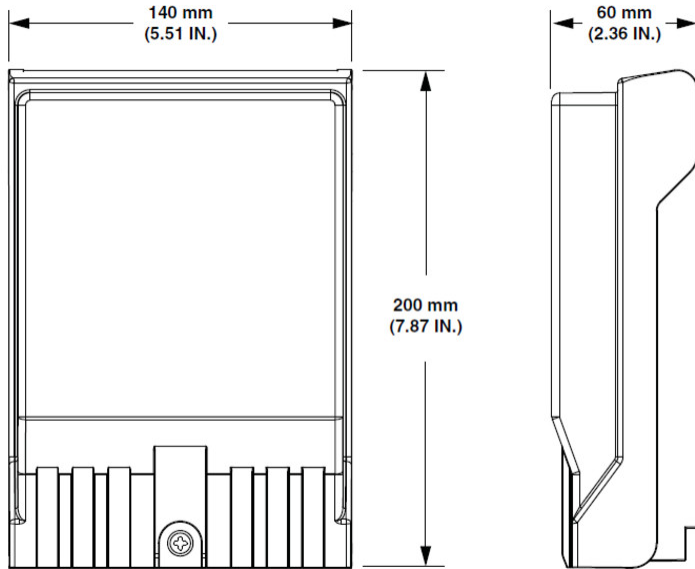

Material Specifications

Material Type Plastic

Optical Specifications

Fiber Mode Singlemode

Environmental Specifications

Environmental Space Indoor

Qualification Standards Telcordia GR-1435-CORE | Telcordia GR-3123-CORE | Telcordia GR-326-CORE

Packaging and Weights

Packaging quantity 1