



FACT® Fiber Optic Patch Chassis, gray, 6E high, 144-port, singlemode, holding 10 hinged trays loaded with SC/UPC adapters

- Designed for use with the all-purpose all-front-access FACT frames and FIST-GR3 frames supporting up to 2,688 LC or 1,344 SC connections in a single frame (FACT-IC frame 2880 LC or 1440 SC)
- Reduced installation and maintenance time via the toolless snap-on design supporting both interconnect and cross-connect applications
- Flexible customization enabled by 4 chassis types (patch-only, patch-splice, pre-cabled and splice-only) to support all ODF applications
- High density through the single FACT element height (1E) being 30% less tall compared to the industry standard panel height (1HU)

Product Classification

Regional Availability	Asia Australia/New Zealand EMEA Latin America North America
Portfolio	CommScope®
Product Type	Fiber patch chassis
Product Brand	FACT®
Product Series	FACT

General Specifications

Functionality	Patching
Application	Compatible with FIST-GR3-style frames
Body Style	Symmetrical
Color	Gray
Growth Configuration	Fully loaded
Interface, front	SC/UPC
Patch Cord Routing	Left sided Right sided
Rack Type	EIA 19 in
Rack Units	4.2
Shelf Movement	Sliding
Total Ports, quantity	144
Transmission Standards	ETSI EN 300 019-1-3 IEC 61300-3-30

Dimensions

760240437 | FACT-6EPATS1

Height	185.7 mm 7.311 in
Width	524 mm 20.63 in
Depth	283 mm 11.142 in

Ordering Tree

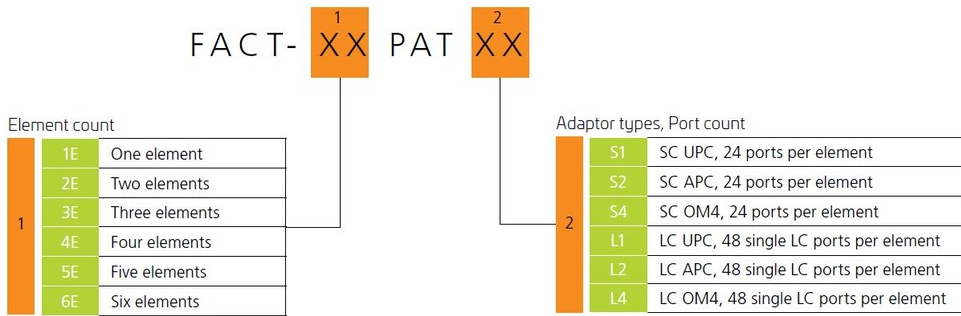

Environmental Specifications

Operating Temperature	-40 °C to +70 °C (-40 °F to +158 °F)
Storage Temperature	-20 °C to +85 °C (-4 °F to +176 °F)
Flammability Rating	UL 94 V-0

Packaging and Weights

Included	Mounting hardware for FACT frame
Packaging quantity	1

Regulatory Compliance/Certifications

Agency	Classification
CHINA-ROHS	Below maximum concentration value
ISO 9001:2015	Designed, manufactured and/or distributed under this quality management system
REACH-SVHC	Compliant as per SVHC revision on www.commscope.com/ProductCompliance
ROHS	Compliant
UK-ROHS	Compliant

